

BS 470/471 610

BS 474/475 610

BS 484/485 610

Combi-steam oven

Table of Contents

Safety Definitions	3	Operating the appliance	19
IMPORTANT SAFETY INSTRUCTIONS	4	Oven interior	19
State of California Proposition 65 Warnings	4	Inserting accessories	19
Proper Installation and Maintenance	4	Turning on	19
Fire Safety	4	Misting	20
Burn Prevention	5	Steam removal	20
Child Safety	6	After every use	20
Cleaning Safety	6	Safety lock	20
Cookware Safety	6	Timer functions	21
Causes of damage	7	Launching the timer menu	21
Environmental protection	7	Timer	21
Tips for saving energy	7	Stopwatch	21
Getting to know the appliance	8	Cooking time	22
Combi-steam oven	8	End of cooking time	23
Displays and controls	9	Sabbath mode and Yom Tov mode	24
Symbols	9	Sabbath mode	24
Colors and display	10	Yom Tov mode	25
Automatic door opening	10	Personal recipes	26
Additional information i and i [®]	10	Recording a recipe	26
Cooling fan	11	Programming a recipe	26
Program selection positions	12	Entering a name	27
Accessories	14	Starting a recipe	27
Special accessories	14	Change recipe	27
Before first use	15	Deleting a recipe	27
Setting the language	15	Core temperature probe	28
Setting the time format	15	Insert the core temperature probe in the food to be cooked	28
Setting the time	15	Setting the core temperature	29
Setting the date format	15	Recommended core temperature values	29
Setting the date	16	Child lock	31
Setting the temperature format	16	Activating the child lock	31
Setting the water filter	16	Deactivating the child lock	31
Setting water hardness	16	Factory setting	32
Completing initial set-up	16	Cleaning and maintenance	34
Calibrating	17	Cleaning agents	34
Grease filter	17	Cleaning aid	35
Cleaning accessories	17	Drying program	36
Water filter	18	Descaling program	36
Operation with or without water filter	18	Removing slide-in racks	37
Change water filter	18	Troubleshooting	38
Activating the appliance	18	Power cut	39
Standby	18	Demo mode	39
Activate appliance	18	Replacing the oven interior lamp	39

Customer service	40
Tables and tips	41
Vegetables	41
Fish	42
Fish – low-temperature steaming	43
Meat – cooking at higher temperatures	44
Meat/poultry – slow cooking	45
Poultry	46
Grilling	47
Side dishes	48
Desserts	48
Other	49
Cakes and cookies	49
Regenerating (warming up)	51
Raising dough	51
Thawing	52
Boiling down	53
Extracting juice (soft fruits)	53
Preparing yoghurt	54
Preparing bulky food	54
Acrylamide in foodstuffs	54

Additional information on products, accessories, replacement parts and services can be found at www.gaggenau.com and in the online shop www.gaggenau-eshop.com

Safety Definitions

WARNING

This indicates that death or serious injuries may occur as a result of non-observance of this warning.

CAUTION

This indicates that minor or moderate injuries may occur as a result of non-observance of this warning.

NOTICE: This indicates that damage to the appliance or property may occur as a result of non-compliance with this advisory.

Note: This alerts you to important information and/or tips.



IMPORTANT SAFETY INSTRUCTIONS

READ AND SAVE THESE INSTRUCTIONS

WARNING

When properly cared for, your new appliance has been designed to be safe and reliable. Read all instructions carefully before use. These precautions will reduce the risk of burns, electric shock, fire, and injury to persons. When using kitchen appliances, basic safety precautions must be followed, including those in the following pages.

State of California Proposition 65 Warnings

WARNING

This product contains chemicals known to the State of California to cause cancer, birth defects or other reproductive harm.

Proper Installation and Maintenance

Have the installer show you the location of the circuit breaker or fuse. Mark it for easy reference.

This appliance must be properly installed and grounded by a qualified technician. Connect only to properly grounded outlet. Refer to Installation Instructions for details.

This appliance is intended for normal family household use only. It is not approved for outdoor use. See the Warranty. If you have any questions, contact the manufacturer.

Do not store or use corrosive chemicals, vapors, flammables or nonfood products in or near this appliance. It is specifically designed for use when heating or cooking food. The use of corrosive chemicals in heating or cleaning will damage the appliance and could result in injury.

Do not operate this appliance if it is not working properly, or if it has been damaged. Contact an authorized servicer.

Do not obstruct oven vents.

Do not repair or replace any part of the appliance unless specifically recommended in this manual. Refer all servicing to a factory authorized service center.

WARNING

Make sure the appliance and lights are cool and power to the appliance has been turned off before replacing the light bulb(s). Failure to do so could result in electrical shock or burns. The lenses (if equipped) must be in place when using the appliance. The lenses (if equipped) serve to protect the light bulb from breaking. The lenses (if equipped) are made of glass. Handle carefully to avoid breaking. Broken glass can cause an injury.

WARNING

Light socket is live when door is open if main power supply is not turned off.

WARNING

Risk of short circuiting! Never allow electrical appliance cords to become pinched in the hot appliance door. The cord's insulation can melt.

Fire Safety

WARNING

NEVER cover any slots, holes or passages in the oven bottom or cover an entire rack with materials such as aluminum foil. Doing so blocks air flow through the oven. Aluminum foil linings may also trap heat, causing a fire hazard.

If materials inside an oven or warming drawer should ignite, keep door closed. Turn off the appliance and disconnect the circuit at the circuit breaker box.

WARNING

Use this appliance only for its intended use as described in this manual. NEVER use this appliance as a space heater to heat or warm the room. Doing so may result in overheating the appliance. Never use the appliance for storage.

Always have a working smoke detector near the kitchen.



IMPORTANT SAFETY INSTRUCTIONS

READ AND SAVE THESE INSTRUCTIONS

In the event that personal clothing or hair catches fire, drop and roll immediately to extinguish flames.

Have an appropriate fire extinguisher available, nearby, highly visible and easily accessible near the appliance.

Smother flames from food fires other than grease fires with baking soda. Never use water on cooking fires.

WARNING

TO REDUCE THE RISK OF INJURY TO PERSONS IN THE EVENT OF A GREASE FIRE, OBSERVE THE FOLLOWING:

- a) SMOTHER FLAMES with a close-fitting lid, cookie sheet, or metal tray, then turn off the burner. BE CAREFUL TO PREVENT BURNS. If the flames do not go out immediately, EVACUATE AND CALL THE FIRE DEPARTMENT.
 - b) NEVER PICK UP A FLAMING PAN – You may be burned.
 - c) DO NOT USE WATER, including wet dishcloths or towels – a violent steam explosion will result.
 - d) Use an extinguisher ONLY if:
 - You know you have a Class ABC extinguisher, and you already know how to operate it.
 - The fire is small and contained in the area where it started.
 - The fire department is being called.
 - You can fight the fire with your back to an exit.
-

Burn Prevention

DO NOT TOUCH HEATING ELEMENTS OR INTERIOR SURFACES OF OVEN - Heating elements may be hot even though they are dark in color. Interior surfaces of an oven become hot enough to cause burns. During and after use, do not touch, or let clothing, potholders, or other flammable materials contact heating elements or interior surfaces of oven until they have had sufficient time to cool. Other surfaces of the appliance may become hot enough to cause burns. Among these surfaces are oven vent openings, surfaces near these openings and oven doors.

Exercise caution when opening the appliance. Standing to the side, open the door (or drawer) slowly and slightly to let hot air and/or steam escape. Keep your face clear of the opening and make sure there are no children or pets near the unit. After the release of hot air and/or steam, proceed with your cooking.

Keep doors shut unless necessary for cooking or cleaning purposes. Do not leave open doors unattended.

Do not heat or warm unopened food containers. Build-up of pressure may cause the container to burst and cause injury.

Always place oven racks in desired location while oven is cool. Always use oven mitts, when the oven is warm. If a rack must be moved while oven is hot, do not let potholder contact the heating elements.

CAUTION

To avoid possible injury or damage to the appliance, ensure rack is installed exactly per installation instructions and not backwards or upside down.

Always use dry potholders. Moist or damp potholders on hot surfaces may result in burns from steam. Do not let potholder touch hot heating elements. Do not use a towel or other bulky cloth.

WARNING

Scalding hazard

Movement when opening the appliance door and when removing the cookware can cause hot liquid to spray out. Do not stand too close to the appliance when opening it. Open appliance door carefully. Remove cookware carefully. Keep children away.

Secure all loose garments, etc. before beginning. Tie long hair so that it does not hang loose, and do not wear loose fitting clothing or hanging garments, such as ties, scarves, jewelry, or dangling sleeves.

Use caution when cooking foods with high alcohol content (e.g. rum, brandy, bourbon) in the oven. Alcohol evaporates at high temperatures. There is a risk of burning as the alcohol vapors may catch fire in the oven. Use only small quantities of alcohol in foods, and open the oven door carefully.

WARNING

Risk of scalding

Hot liquid may spill over the sides of cooking accessories when they are removed from the cooking compartment. Carefully remove cooking accessories with oven mitts.



IMPORTANT SAFETY INSTRUCTIONS

READ AND SAVE THESE INSTRUCTIONS

WARNING

Risk of scalding

Hot steam can escape when you open the appliance door. Steam is not visible at certain temperatures. Do not stand too close to the appliance when opening it. Open the appliance door with caution. Keep children away.

WARNING

Risk of burns

Hot steam can leak during operation. Do not touch the ventilation openings. Keep children away.

Child Safety

When children become old enough to use the appliance, it is the legal responsibility of the parents or legal guardians to ensure that they are instructed in safe practices by qualified persons.

Do not allow anyone to climb, stand, lean, sit, or hang on any part of an appliance, especially a door, warming drawer, or storage drawer. This can damage the appliance, and the unit may tip over, potentially causing severe injury.

Do not allow children to use this appliance unless closely supervised by an adult. Children and pets should not be left alone or unattended in the area where the appliance is in use. They should never be allowed to play in its vicinity, whether or not the appliance is in use.

CAUTION

Items of interest to children should not be stored in an appliance, in cabinets above an appliance or on the backsplash. Children climbing on an appliance to reach items could be seriously injured.

Cleaning Safety

Risk of severe burns! Do not clean the appliance immediately after turning it off. The water in the evaporator dish is still hot. Wait until the appliance has cooled down.

Keep oven free from grease build up.

WARNING

Risk of injury

Scratched glass in the appliance door can burst. Do not use any glass scrapers or strong or abrasive cleaning agents.

WARNING

Risk of electrical shock

Moisture entering the appliance can cause an electrical shock. Don't use a high-pressure cleaner or steam cleaner.

Cookware Safety

Do not place food directly on oven bottom.

Follow the manufacturer's directions when using cooking or roasting bags.

WARNING

Risk of electric shock

Use of a wrong core temperature probe can damage the insulation. Use only the core temperature probe intended for this appliance.

Ovenware must be heat and steam resistant. Silicone baking pans are not suitable for Combination mode.

When using Steam mode with a perforated cooking pan, always slide the baking pan underneath it. The pan will catch any drippings.

The oven bottom and the evaporator dish must always remain clear. Always place ovenware on the rack or in the perforated cooking pan.

Causes of damage

NOTICES:

- Do not place anything directly on the oven floor. Do not line it with aluminum foil. Heat build-up can damage the appliance.
- The oven bottom should always remain clear. Always place dishes in a perforated baking pan or on a rack.
- We recommend you install a descaling system for hard mains water. You can inquire with your waterworks to obtain information about your mains water.
- Aluminum foil may not contact the door pane in the oven. This can cause permanent discoloration of the door pane.
- Dishes must be heat and steam resistant. Silicone baking dishes are not suited for combination operation with steam.
- Use only original accessories in the oven interior. Rusting material (such as serving platters or knives and forks) can cause corrosion in the oven interior.
- Use original small parts (e.g. knurled nuts) only. Reorder small parts through out spare parts service if these should be lost..
- When steaming with a perforated baking dish, always push the baking sheet or the unperforated baking dish beneath it. This will catch drippings.
- Do not leave moist groceries in a closed oven for an extended period of time. It can lead to corrosion inside the oven.
- Salt, spicy sauces (e.g. ketchup or mustard) or salted dishes (e.g. cured roast) contain chlorides and acids. These corrode the surfaces of stainless steel. Always remove residues immediately.
- Fruit juice can leave stains in the oven. Always remove fruit juice immediately and wipe up first with a damp and then a dry cloth.
- Your appliance's oven interior consists of high-grade stainless steel. Corrosion can occur in the oven interior if it is not cared for properly. Observe the care and cleaning notes in the operating instructions. After every use, clean the oven interior straight after the appliance has cooled down. After cleaning, dry the oven interior with the drying program.

- Do not detach the door seal. The appliance door will no longer close properly if the door seal is damaged. Adjoining furniture frontages may be damaged. Have the door seal replaced.
- Do not hold or carry the appliance by the door handle. The door handle cannot carry the weight of the device and could break off.

Environmental protection

Unpack the appliance and dispose of the packaging in line with environmental requirements.

Tips for saving energy

- Open the appliance door as little as possible while cooking.
- Use dark, black-painted or enamelled baking forms. These absorb the heat particularly well.
- It is best to bake several cakes in succession. The steam oven is still warm. This shortens the baking time for the second cake. You can also slide in two loaf tins next to each other.
- For longer cooking times, you can switch off the steam oven 10 minutes before the end of the cooking time and you can use the residual heat to finish cooking.
- When steaming, you can cook simultaneously on several levels. If dishes require different cooking times, insert the dishes that require the longest time first.

Getting to know the appliance

You will get to know your new appliance here. We explain the control panel and the individual controls to

you. You are informed about the oven interior and accessories.

Combi-steam oven

These instructions apply to different versions of the appliance. Slight deviations are possible depending on the appliance type.

Operation is identical for all appliance versions.

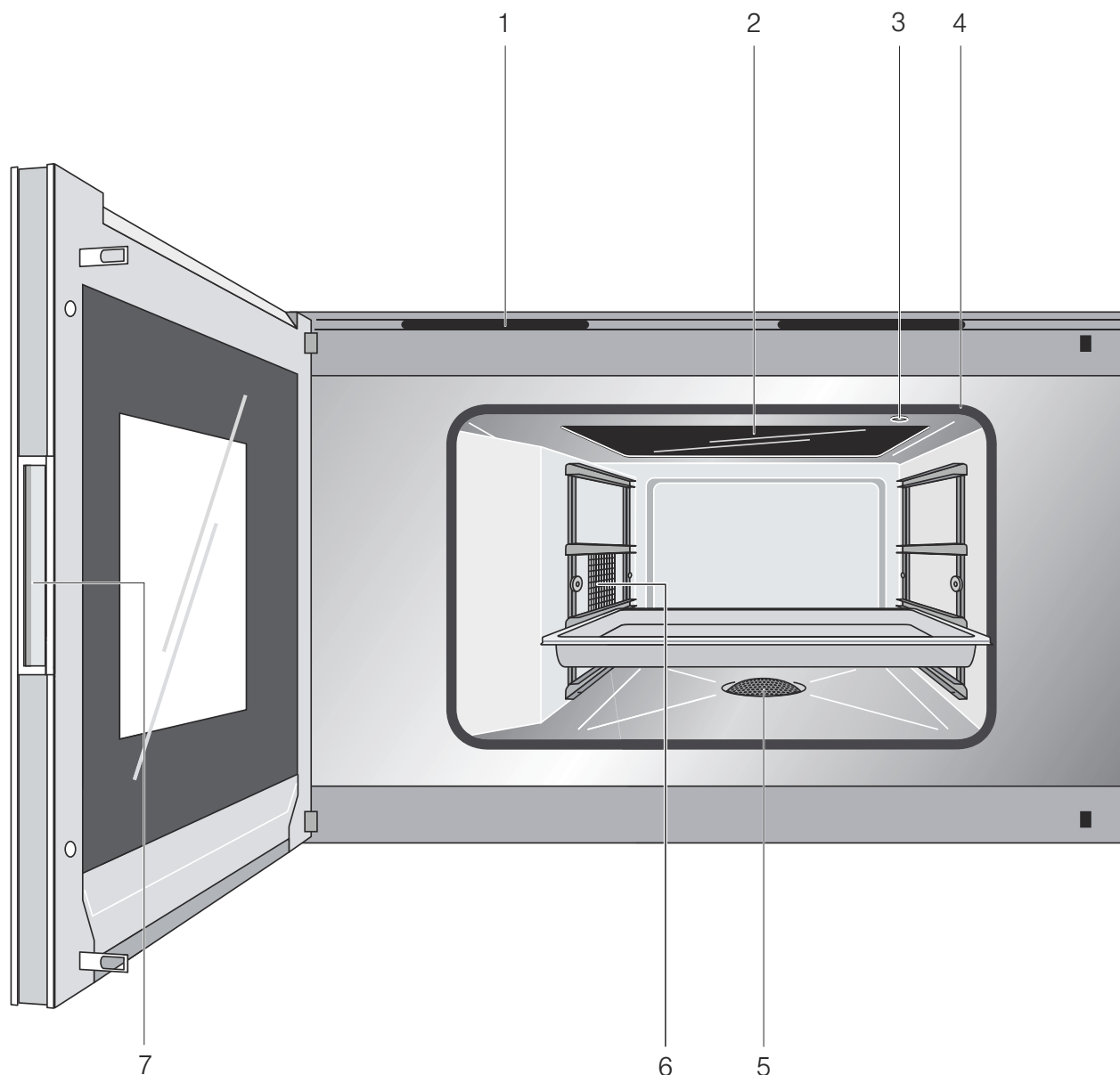

1	Ventilation slots
2	Glass ceramic grill tray
3	Socket for core temperature sensor
4	Door seal
5	Drainage sieve
6	Grease filter
7	Recessed handle

Do not obstruct oven vents.

NOTICE: Do not place food directly on oven bottom.

Displays and controls

These instructions apply to different versions of the appliance. Slight deviations are possible depending on the appliance type.

Operation is identical for all appliance versions.

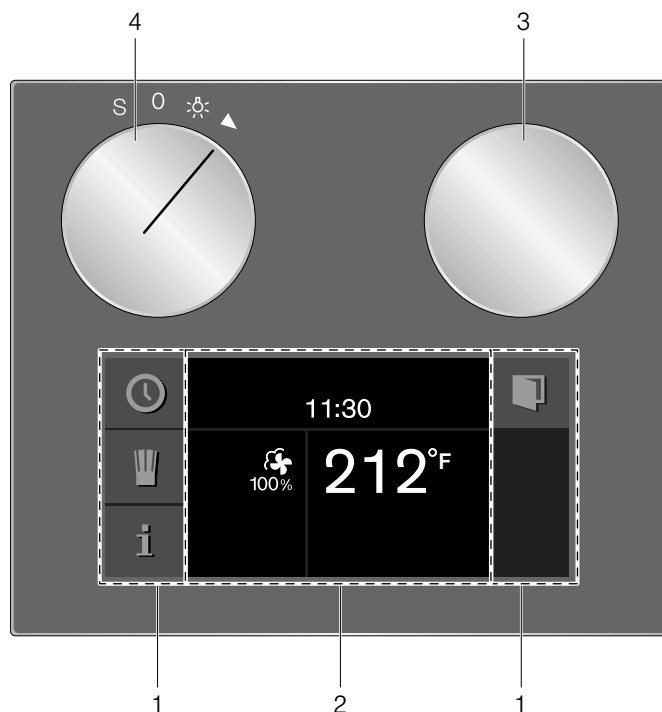

1	Control panel	These areas are touch-sensitive. Touch a symbol to select the applicable function.
2	Display	The display shows current settings and options, for example.
3	Rotary selector	With the rotary selector you can select the temperature and make other settings.
4	Program selector	With the program selector, you can select the heating function, the cleaning function or the basic settings.

Symbols

Symbol	Function
▶	Start
■	Stop
	Pause/end
X	Cancel
C	Delete
✓	Confirm/save settings
>	Selection arrow
🚪	Open appliance door
i	Launching additional information
⤴	Preheating with status display
🍷	Launching personal recipes
rec	Recording a menu
🔧	Edit settings
>A [^]	Enter a name
✕	Delete letters
🔒	Child lock
🕒	Launching the timer menu
🕒	Launching the Sabbath mode
🔪	Demo mode
🔪	Core temperature probe
💧	Misting
💧	Starting steam removal
💧	Stopping steam removal

Colors and display

Colors

The various colors serve to guide you in the various adjustment situations.

Orange	First settings Main functions
Blue	Basic settings Cleaning
White	Adjustable values

Presentation

The presentation of symbols, values or the entire display changes depending on the situation.

Zoom	The display of the setting you are just changing is enlarged. Just before it elapses, a duration that is just elapsing is enlarged (e.g. the last 60 seconds in the case of timers).
Minimized display screen	After a short time, the display screen is minimized and only the most important things are displayed. This function is the default and can be modified in the basic settings.

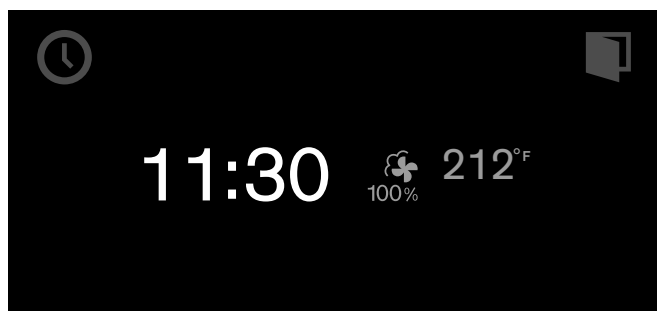

Automatic door opening

When you touch the  symbol, the appliance door springs open and you can open it fully with the handle recess at the side.

Automatic door opening does not work when the child lock is activated or in the event of a power failure. You can open the door manually with the handle recess at the side.

Additional information **i** and **i**[Ⓢ]

By touching the **i** symbol, you can call up additional information. For example, information on the heating function set or on the current temperature of the cooking compartment.

Note: During continuous operation, small fluctuations in temperature are normal after the oven has heated up.

The **i**[Ⓢ] symbol is displayed for important information and action prompts. Important information on safety and operation mode are occasionally shown automatically. These messages either disappear automatically after a few seconds or must be confirmed with .

Cooling fan

Your appliance has a cooling fan. The cooling fan switches on during operation. Depending on the appliance version, the warm air escapes above or under the door.







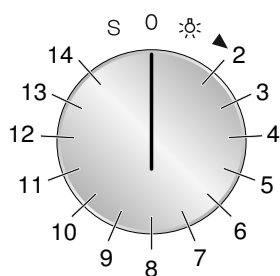

After removing cooked food, keep the door closed until the appliance cools down. The appliance door must not be left ajar, as adjoining kitchen furniture may be damaged. The cooling fan continues to run for a while and then switches off automatically.









⚠ CAUTION

Do not cover up the ventilation slots. Otherwise, the appliance will become overheated.

Program selection positions



Position	Function / heating type	Temperature	Use
0	Zero position		
☀	Light		
2	 Convection + 100% Humidity	85 - 450° F (30 - 230° C) Default temperature 212° F (100° C)	Steaming at 160 - 212° F (70° C - 100° C): For vegetables, fish and side dishes. Meals are surrounded entirely by steam Combined operation at 250 - 450° F (120 - 230° C): for puff pastry, bread and bread rolls. Hot air and steam are combined.
3	 Convection + 80% Humidity	85 - 450° F (30 - 230° C) Default temperature 340° F (170° C)	Combined operation: for puff pastry, fish and poultry. Hot air and steam are combined.
4	 Convection + 60% Humidity	85 - 450° F (30 - 230° C) Default temperature 340° F (170° C)	Combined operation: for yeast dough and bread. Hot air and steam are combined.
5	 Convection + 30% Humidity	85 - 450° F (30 - 230° C) Default temperature 340° F (170° C)	Cooking in own moisture: for cakes and biscuits When you select this mode, no steam is generated, but the ventilation flap is closed. Thus, the moisture escaping from the food stays in the oven interior and prevents drying out of prepared foods.
6	 Convection + 0% Humidity	85 - 450° F (30 - 230° C) Default temperature 340° F (170° C)	Hot air: for cakes, biscuits and soufflés. The fan on the rear wall distributes the heat evenly in the cooking compartment
7	 Full surface grill + circulated air	85 - 450° F (30 - 230° C) Default temperature 445° F (230° C)	For vegetable and scampi skewers.
8	 Full surface grill	85 - 450° F (30 - 230° C) Default temperature 445° F (230° C)	For grilled vegetables, cooking 'au gratin' (e.g. baiser on a cake) and grilled toast.
9	 Full surface grill level 1 + humidity	85 - 450° F (30 - 230° C) Default temperature 340° F (170° C)	Grilling combined with humidity: for casserole dishes and gratin.
10	 Full surface grill level 2 + humidity	85 - 450° F (30 - 230° C) Default temperature Default temperature 340° F (170° C)	Grilling combined with humidity: for stuffed vegetables. The grilling level will be increased.

Position	Function / heating type	Temperature	Use
11	 Dough proofing	85 - 120° F (30 - 50° C) Default temperature 100° F (38° C)	Rising: for yeast and sour dough. The dough rises much faster than at room temperature. Hot air and steam are combined to ensure the dough surface does not dry out. The optimum temperature setting for yeast dough is 100° F (38° C).
12	* Defrosting	100 - 140° F (40 - 60° C) Default temperature 115° F (45° C)	For vegetables, meat, fish and fruit. Thanks to the moisture, heat is transferred to meals evenly. Meals do not dry out and do not lose their shape.
13	 Regenerating	140 - 360° F (60 - 180° C) Default temperature 250° F (120° C)	For cooked and baked food. Pre-cooked food is gently heated up again. Thanks to the supply of steam, cooked food is not dried out. Regenerating pre-cooked meals on a plate at 250° F (120° C) and baked items at 360° F (180° C).
14	 Slow cooking	85 - 200° F (30 - 90° C) Default temperature 160° F (70° C)	Low-temperature cooking for meat. Gentle, slow cooking for a particularly tender result.
S	 Factory setting		Your appliance can be individually adjusted in the basic settings.
	 Cleaning aid		The cleaning aid removes soiling with steam.
	 Drying program		The drying program dries the oven interior after steaming or cleaning.
	 Descaling program		With the descaling program you remove limescale from the oven interior.
	 Water filter change		Changing the water filter cartridge if the descaling filter has been installed.
	 Delete descaling reminder		Clear the descaling reminder in the display after the descaling process.

Accessories

Use only the accessories included or obtainable from after-sales service. It has been specially adapted to your appliance. Make sure you always insert accessories into the interior the right way round.

Your appliance comes with the following accessories:



Rack

for cookware, cake pans and casseroles and for roasts

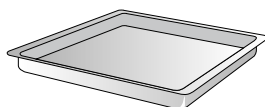

Stainless steel cooking receptacle, unperforated, GN 2/3, 40 mm deep

for cooking rice, pulses and cereals, for baking cake baked on trays and for collecting dripping liquid during steaming

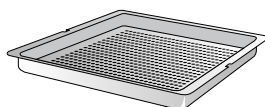

Stainless steel cooking receptacle, GN 2/3, 40 mm deep

for steaming vegetables or fish, for extracting berry juices and for thawing

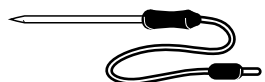

Core temperature probe

for precise preparation of meat, fish, poultry and bread

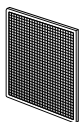

Grease filter

protects the fan of the side panel of the cooking compartment from becoming dirty (e.g. from spattering)

Water inlet hose, 3 m

Water outlet hose, 3 m

Special accessories

You can order the following accessories from your specialist dealer:

- BA 476 310 Handle, stainless steel for BS 470/471/474/475
- BA 478 310 Handle, stainless steel for BS 484/485
- GF 111 100 Descaling and neutralising filter (filter head with filter for first installation)
- GF 121 110 Filter cartridge for descaling and neutralising filter
- GN 114 130 Stainless steel cooking insert GN 1/3, unperforated, 40 mm deep, 1.5 l
- GN 114 230 Stainless steel cooking insert GN 2/3, unperforated, 40 mm deep, 3 l
- GN 124 130 Stainless steel cooking insert GN 1/3, perforated, 40 mm deep, 1.5 l
- GN 124 230 Stainless steel cooking insert GN 2/3, perforated, 40 mm deep, 3 l
- GN 340 230 Cast aluminum roaster GN 2/3, 165 mm high, non-stick
- GN 410 130 Stainless steel cover GN 1/3
- GN 410 230 Stainless steel cover GN 2/3
- GR 030 062 wire rack, chrome-plated, with feet
- GZ 010 011 Inlet and outlet hose extension, 2 m

Use the accessories only as indicated. The manufacturer assumes no liability for incorrect usage of the accessories.

Before first use

Here you find out what you have to do before preparing meals with your appliance for the first time. Read the section entitled **Important safety notes** beforehand.

The appliance must be completely fitted and connected.

The "First settings" menu appears in the display after the mains has been connected. You can now set your new appliance:

- Language
- Time format
- Time
- Date format
- Date
- Temperature format
- Water hardness

Notes

- The "First settings" menu only appears the first time the appliance is switched on after connection to the mains or if the appliance had no power supply for several days. After connection to the power, the GAGGENAU logo first appears for about 30 seconds, after which the "First settings" menu appears automatically.
- You can change the settings at any time (see the section entitled **Factory setting**).

Setting the language

The default language appears in the display.

- 1 Select the desired display language with the rotary selector.
- 2 Confirm with ✓.

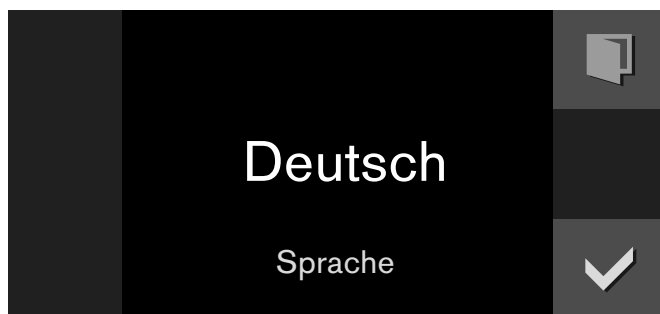

Note: When the language is changed, the system is restarted; this procedure takes a few seconds.

Setting the time format

the two possible formats 24h and AM/PM appear in the display. The default format is 24h.

- 1 Set the required format with the rotary selector.
- 2 Confirm with ✓.

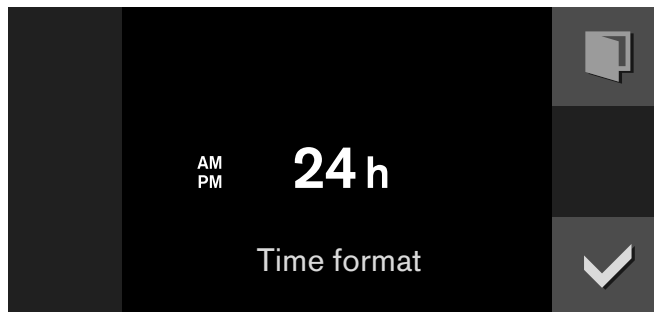

Setting the time

The time appears in the display.

- 1 Set the required time with the rotary selector.
- 2 Confirm with ✓.

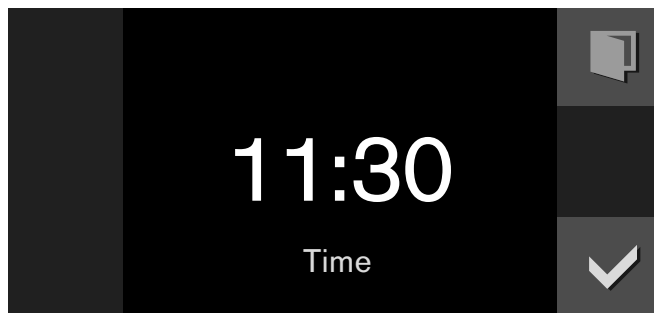

Setting the date format

The three possible formats D.M.Y, D/M/Y and M/D/Y appear in the display. The D.M.Y is the default.

- 1 Set the required format with the rotary selector.
- 2 Confirm with ✓.

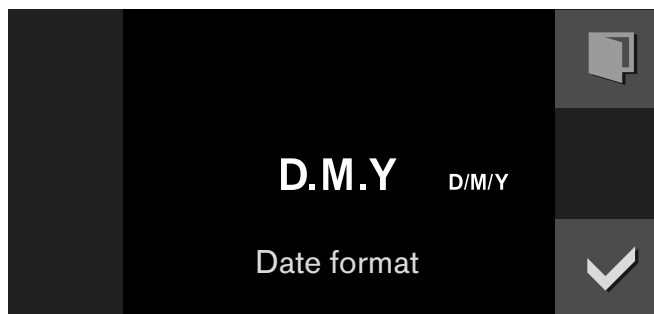

Setting the date

The default date appears in the display. The day setting is already active.

- 1 Set the required day with the rotary selector.
- 2 Switch to the month setting with the > symbol.
- 3 Set the month with the rotary selector.
- 4 Switch to the year setting with the > symbol.
- 5 Set the year with the rotary selector.
- 6 Confirm with ✓.

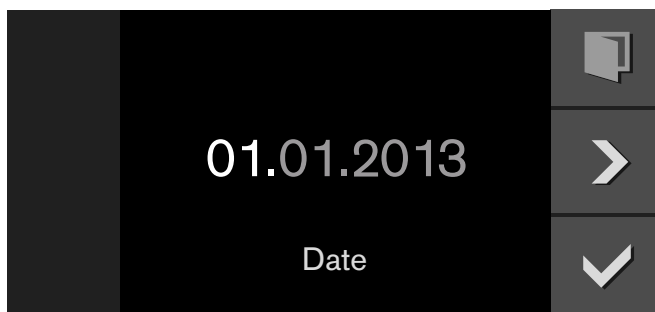

Setting the temperature format

The two possible formats °C and °F appear in the display. The °C format is selected by default.

- 1 Set the required format with the rotary selector.
- 2 Confirm with ✓.

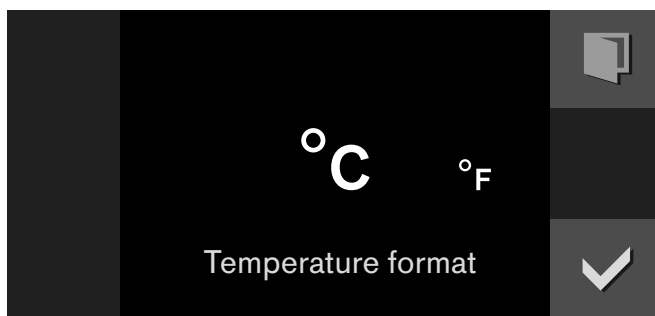

Setting the water filter

"Water filter" appears in the display. The default is "Available".

It is recommended to install the descaling system GF 111 100 if the water hardness exceeds 7° dH (carbonate hardness 5° dH).

- 1 Use the rotary selector to select "Available" (with water filter) or "Not available" (without water filter).
- 2 Confirm with ✓.
- 3 If water filter "Available" has been selected: "Water filter capacity" is shown in the display.

- 4 Turn the rotary selector to select the capacity of the filter cartridge (between 100 - 9000 liters). Refer to the instructions included with the filter cartridge.
- 5 Confirm with ✓.

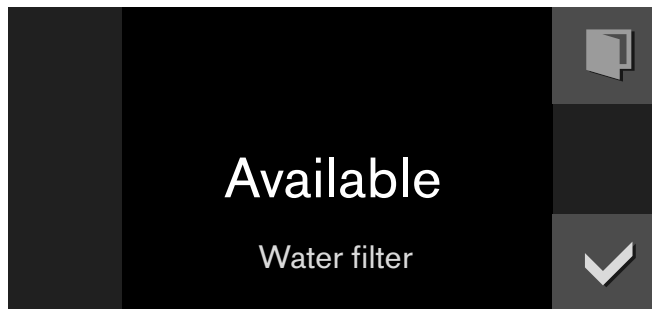

Setting water hardness

"Water hardness" appears in the display.

- 1 Check the mains water with the included carbonate hardness test: fill the small measurement tube with mains water up to the 5 ml mark.
- 2 Add drops of indicator solution until the color changes from purple to yellow. **Important:** count the drops and carefully swing the measurement tube after every drop until the liquids have mixed thoroughly. The number of drops corresponds to the water hardness.
- 3 Set the measured water hardness with the rotary selector. The value 12 is set by default.
- 4 Confirm with ✓.

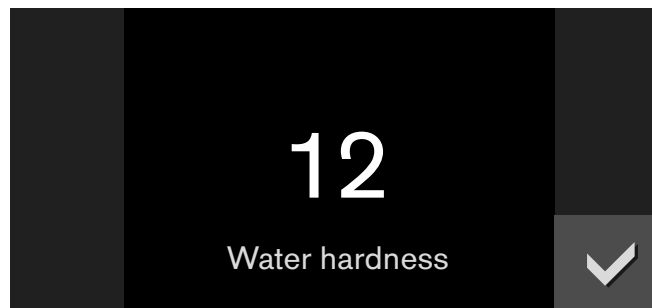

Completing initial set-up

"Initial set-up complete. Please calibrate the appliance before first cooking" appears in the display.

Confirm with ✓.

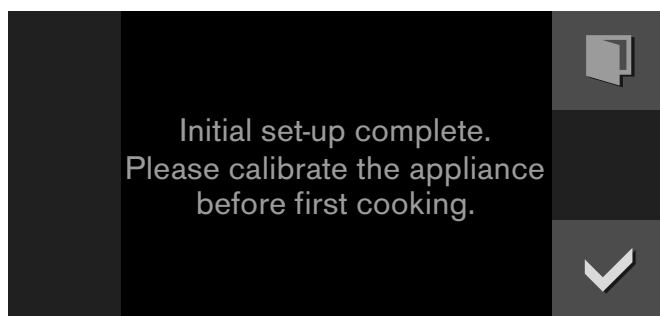

The appliance enters the standby mode and the standby display appears. The appliance is now ready for operation.

Calibrate the appliance before steaming for the first time. The appliance sets the boiling point.

Calibrating

The boiling point of water depends on barometric pressure. As air pressure drops with increasing elevation, the boiling point drops as well. During calibration, the appliance sets the boiling point to the pressure conditions at the place where it is installed.

It is important for the appliance to steam for 20 minutes at 212° F (100°C) without interruption. Do not open the appliance door during this time.

Notes

- Calibrate the appliance only when it is cold.
 - During calibration, the appliance generates more steam than it normally would do.
- 1 Set the function selector to **S**.
 - 2 Select "Basic settings" using the rotary selector.
 - 3 Touch the ✓ symbol.
 - 4 Select "Calibration" using the rotary selector.
 - 5 Touch the ↘ symbol.
 - 6 Remove all accessories from the oven interior and touch the ✓ symbol.
 - 7 The duration of 20:00 minutes appears. Touch ▶ to start calibration.

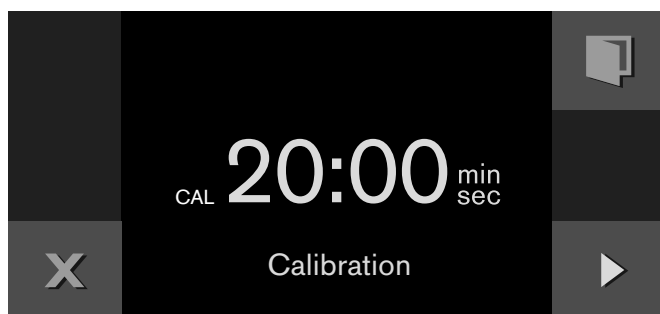

Calibration begins. The elapsing time is shown on the display.

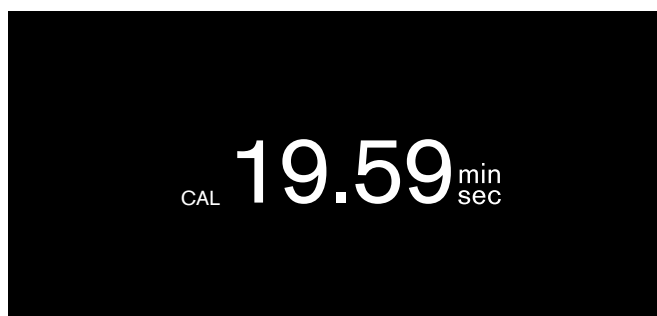

Note: Do not interrupt calibration. Do not turn the function selector. Do not open the appliance door.

A message appears in the display once calibration has ended. Touch ✓ to confirm and turn the function selector to **0**.

After a removal

Repeat calibration so that the appliance will automatically adapt again to the new location.

After resetting to factory settings

After resetting to factory settings in the basic settings menu the appliance has to be recalibrated.

After a power failure

The appliance saves the calibration settings, even after a power failure or a disconnection from the mains. It need not be recalibrated.

Grease filter

Hook the enclosed grease filter onto the hot air grill in the side wall of the cooking compartment.

Remove the left slide-in rail first (see section entitled *Removing slide-in rails*).

Leave the grease filter in the cooking compartment for all applications. Clean the grease filter with hot soapy water or in the dishwasher every time heavy dirt deposits have been left behind after cooking.

Cleaning accessories

Before using accessories for the first time, thoroughly clean them with hot soapy water and a soft dish cloth.

Water filter

Operation with or without water filter

You can use the appliance with or without a water filter.

It is recommended to install the descaling system GF 111 100 if the water hardness exceeds 7°dH (carbonate hardness 5°dH).

Change water filter

Filter cartridges should be replaced regularly. Replacement cartridges are available from after-sales service or in the online shop (order number GF 121 110).

The capacity of the filter cartridge depends on the frequency of use of the appliance and your regional water hardness. A message will appear in the display to remind you when the filter needs to be replaced. Regardless of the actual amount of water filtered the filter cartridge needs to be changed after 12 months at the latest.

- 1 Set the function selector to **S**. Select "Water filter change" using the rotary selector.
- 2 The 🕒 symbol is displayed. Confirm with ✓.
- 3 Change the water filter. Refer to the instructions included with the filter cartridge. Confirm with ✓.
- 4 "Select water filter capacity" is shown in the display. Confirm with ✓.
- 5 Turn the rotary selector to select the capacity of the filter cartridge (between 100 - 9000 liters). Confirm with ✓.

The water filter change is complete. Touch the ✓ symbol. The appliance is now ready for operation.

Activating the appliance

Standby

The appliance is in the standby mode when no function is set or the child lock is activated.

The control panel's brightness is reduced in the standby mode.

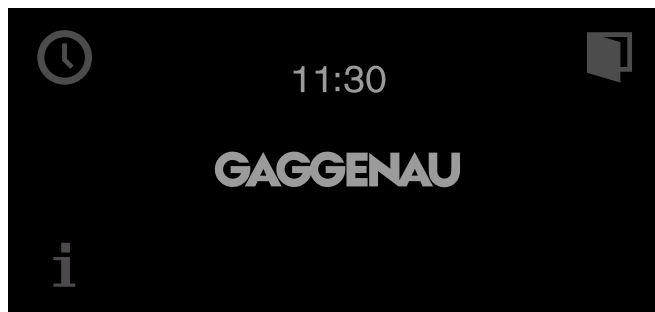

Notes

- There are various displays for the standby mode. The GAGGENAU logo and the time are set by default. Refer to the section entitled **Factory setting** if you would like to change the display.
- The display's brightness depends on the vertical viewing angle. You can adjust the display by way of the "Brightness" setting in the factory settings.

Activate appliance

In order to exit standby mode, you can either

- Set the function selector,
- Touch a control panel,
- or open or close the door.

Now you can set the desired function. Read the appropriate chapters to learn how to set functions.

Notes

- If "Standby display = off" is selected in the factory setting, you must turn the function selector to exit the standby mode.
- The standby display appears again if you have not made any settings for a long while after activation.
- The cooking compartment lighting goes out after a little while if the door is open.

Operating the appliance

Oven interior

The cooking compartment has four shelf positions. The shelf positions are counted from the bottom up.

Note: When steaming, defrosting, dough proofing and regenerating, you can use up to three insertion levels at the same time (levels 2, 3 and 4). You can only bake on one level, use level 2 when baking (or level 1 for higher cake tins).

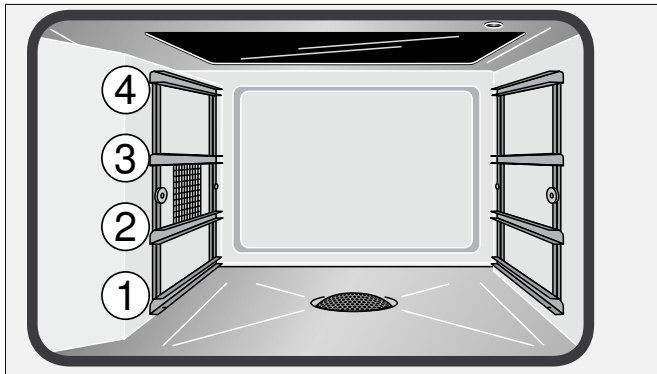

CAUTION

Do not place anything on the cooking compartment floor. Do not cover it with aluminium foil. A build-up of heat could damage the appliance or cause injury.

CAUTION

The cooking compartment floor must always be kept clear. Always place ovenware in a perforated cooking container or on a wire rack.

CAUTION

Do not slide any accessories between the shelf positions, or they may tip.

Inserting accessories

The rack and the perforated cooking receptacle feature a latching function. The latching function prevents tilting of accessories when pulling them out. You must insert accessories in the cooking interior correctly so that tilt protection will work. When removing accessories, you must raise them slightly.

When inserting the rack, make sure

- that the engaging lug (a) points upward
- that the rack's safety clip is at the rear and top.

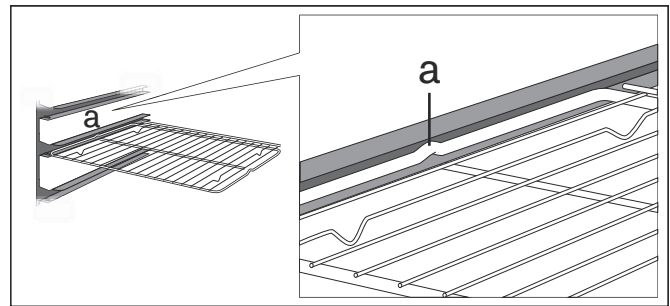

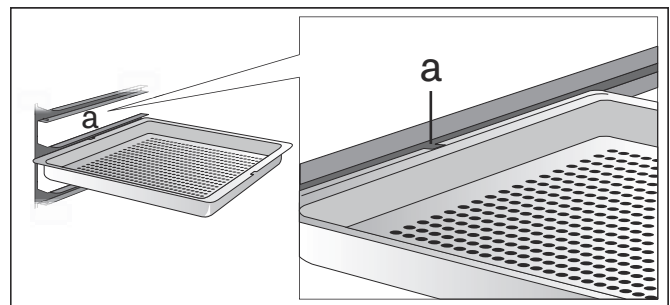

When pushing in the perforated cooking receptacle, make sure that the recess (a) points to the side.



Turning on

- 1 Set the required heating mode using the function selector. The chosen heating mode and the default temperature are displayed.
- 2 If you want to change the default temperature: set the required temperature with the rotary selector.

The preheating symbol  appears on the display. The bar continuously shows the preheating status. When the set temperature is reached, a signal sounds and the preheating symbol  goes off.

Note: The oven interior lighting stays switched off at a temperature setting below 160° F (70 °C).

Switching off:



Turn the function selector to 0.

Misting

Misting brings additional steam to the oven interior. You can add moisture to food while cooking, for example bread and rolls.

Misting is only possible with these heating functions:

- Convection + 30% Humidity
- Convection + 0% Humidity
- Full surface grill + circulated air
- Full surface grill

Touch the  symbol as long as you want to add steam, up to 8 seconds. After waiting at least one second, you can trigger misting again by touching the  symbol.

Steam removal

Steam removal brings cold water to the cooking compartment. This cools down the cooking compartment, the steam condenses on the wall of the cooking compartment. This reduces the steam escaping when opening the door.

WARNING

Risk of scalding

Hot water may drip from the door when opened.

You can use the steam removal function only up to a temperature of 130 °C with the following heating functions:

- Convection + 100% Humidity
- Convection + 80% Humidity
- Convection + 60% Humidity
- Full surface grill level 1 + Humidity
- Full surface grill level 2 + Humidity

Starting steam removal:

Touch the  symbol. Steam removal lasts about 20 seconds. The heating remains switched off during steam removal.

Stopping steam removal prematurely:

Open the oven door or touch the  symbol

Note: The steam removal function remains available for a short time after turning off the appliance.

After every use

- 1 Remove soiling from the oven interior as soon as it has cooled down. Baked-in residue is much harder to remove later on.
- 2 Wipe out the cooled down oven interior and dry them well with a soft cloth.
- 3 Wipe furnishings or handles dry if condensate has collected on them
- 4 Dry the oven interior with the drying program (see section entitled ***Drying program***) or leave the appliance door open until the interior has dried completely.

Safety lock

For your protection, the appliance has a safety shut-off feature. Every heating operation is switched off after 12 hours if the appliance is not operated during this time. A message appears in the display.

Exception:
programming with the long-term timer.

Turn the program selection to **0**, after which you can operate the appliance in the manner to which you are accustomed.

Timer functions

In the timer menu, set:

- ⌚ Timer
- ⌚ Stopwatch
- 🕒 Cooking time (not in the idle state)
- 🕒 Cooking time end (not in the idle state)

Launching the timer menu

You can launch the timer menu from any mode. Only from the factory settings, program selection is set to **S**, the time menu is not available.

Touch the ⌚ symbol.

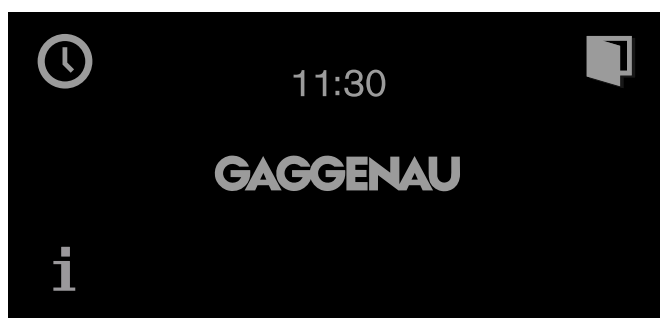

The timer menu appears.

Timer

The timer runs independently of the other appliance functions. You can enter a maximum of 90 minutes.

Setting the timer

- 1 Call up the Timer menu.
The "Timer" function ⌚ is displayed.
- 2 Turn the rotary selector to set the desired time.

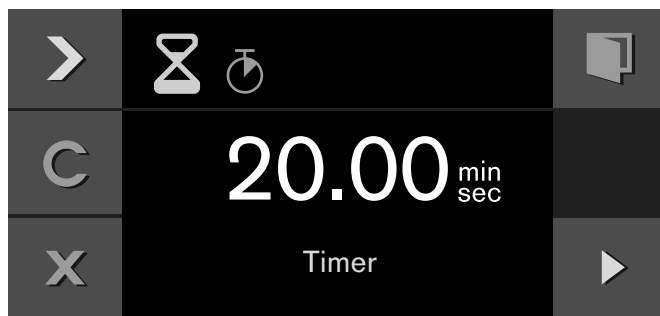

- 3 Start with ▶.

The Timer menu closes and the timer starts to run. The symbol for the timer ⌚ appears on the display and the time can be seen counting down.

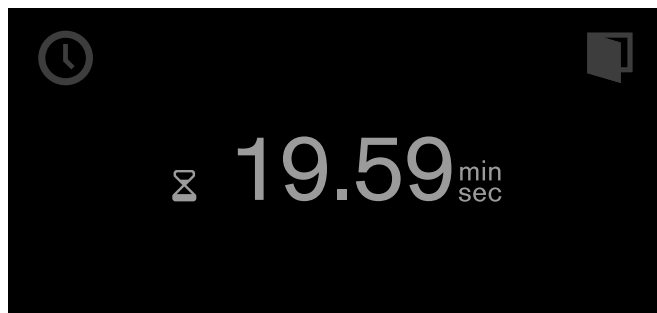

A signal sounds once the time has elapsed. The audible signal ceases if you touch the ✓ symbol.

You can exit the Timer menu at any time by touching the ✕ symbol. This way, the settings are lost.

Suspend timer:

Call up the Timer menu. Select the "Timer" function with >, select ⌚, and touch the || symbol. To let the timer run on, touch the ▶ symbol.

Switch off the timer early:

Call up the Timer menu. Select the "Timer" function with >, select ⌚, and touch the C symbol.

Stopwatch

The stopwatch runs independently of the other appliance functions.

The stopwatch counts up from 0 seconds to 90 minutes.

It has a pause function. Therefore, you can stop the timer in between times.

Starting the stopwatch

- 1 Launch the timer menu.
- 2 With >, select the "Stopwatch" function ⌚.

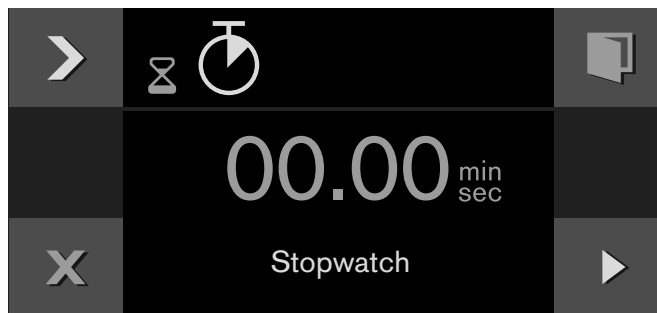

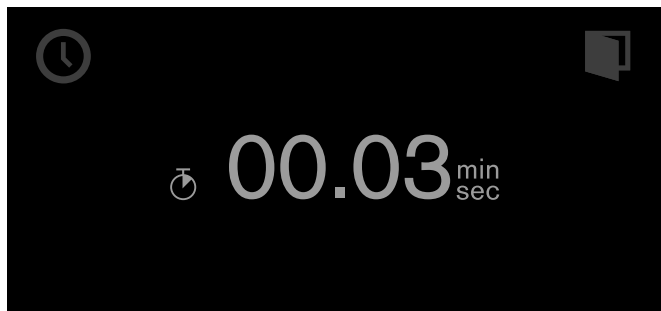

- 3 Start with ▶.

The timer menu is closed and the time runs. The  symbol and the elapsing timer are shown in the display.



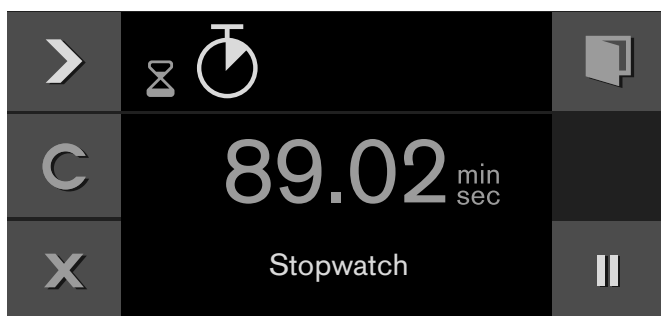

Stopping and restarting the stopwatch

- 1 Launch the timer menu.
- 2 With , select the "Stopwatch" function .
- 3 Touch the  symbol.





The time stops. The symbol changes to Start  again.

- 4 Start with .

The time continues to run. Once 90 minutes have been reached, the display pulsates and a signal sounds. It goes off when you touch the  symbol. The  symbol disappears from the display. The operation has ended.

Switching off the stopwatch:

Launch the timer menu. With , select the "Stopwatch" function  and touch the  symbol.

Cooking time

If you set a cooking time for your meal, the appliance switches off heating automatically after this time has elapsed.

You can set a cooking time from 1 minute to 23:59 hours.

Setting the cooking time

You have set the heating function and temperature and you have placed your dish in the oven interior.

- 1 Touch the .

- 2 With , select the "Cooking time" function .

- 3 Set the required cooking time with the rotary selector.





- 4 Start with .

The appliance starts. The timer menu is closed. The temperature, the operating mode, the remaining cooking time and the end of the cooking time appear in the display



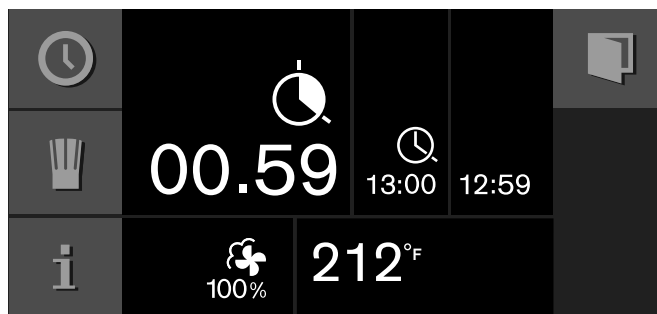

One minute before expiration of the cooking time, the expiring cooking time is enlarged in the display.







The appliance switches off after expiration of the cooking time. The  pulsates and a signal sounds. It goes off prematurely if you touch the  symbol, open the appliance door or set the program selection to 0.

Changing the cooking time:

Launch the timer menu. With , select the "Cooking time" function . Set the cooking time with the rotary selector. Start with .

Clearing the cooking time:

Launch the timer menu. With , select the "Cooking time" function . Clear the cooking time with . Return to normal operation with .

Canceling the entire operation:

Set the program selection to 0.

Note: You can also change the heating function and temperature during the cooking time.

End of cooking time

You can defer the end of the cooking time until later.

Example: it is 2 pm. The meal takes 40 minutes to cook. It should be ready by 3.30 pm.

Enter the cooking time and shift the end of the cooking time to 3.30 pm. The electronic circuitry calculates the starting time. The appliance starts automatically at 2:50 pm and switches off at 3.30 pm.

Note that easily perishable foodstuffs must not be left in the oven for too long.

Shifting the end of the cooking time

You have set the heating function, the temperature and the cooking time.

- 1 Touch the ⌚ symbol.
- 2 With ➤, select the "End of cooking time" function ⌚.



- 3 Set the required cooking time end with the rotary selector.
- 4 Start with ▶.



The appliance assumes a waiting mode. The operating mode, the temperature, the cooking time and the end of the cooking time appear in the display. The appliance starts at the calculated time and switches off automatically when the cooking time has elapsed.

Note: If the ⌚ symbol flashes: you have not set a cooking time. Always set a cooking time first.

The appliance switches off after expiry of the cooking time. The ⌚ pulsates and a signal sounds. It goes off prematurely if you touch the ✓ symbol, open the appliance door or set the program selection to 0.

Changing the cooking time end:

Launch the timer menu. With ➤, select "End of cooking time" ⌚. Set the required cooking time end with the rotary selector. Start with ▶.

Canceling the entire operation:

Set the program selection to 0.

Sabbath mode and Yom Tov mode

Sabbath mode

With this function, the appliance maintains a temperature between 120 and 450°F (50 and 230°C) with the convection heating function.

You can keep dishes warm for up to 74 hours without having to switch on or off.

Note that easily perishable foodstuffs must not be left in the oven for too long.

Note: You must activate the Sabbath mode in the factory setting in order to operate the mode.

Follow these steps:

- 1 Set the program selector to **S**.
- 2 Select "Factory setting" with the rotary selector.
- 3 Confirm by touching the ✓ symbol.
- 4 Rotate the selector to Sabbath mode (🕒).
- 5 Confirm by touching the ✓ symbol.
- 6 Rotate the selector to "activate".
- 7 Confirm by touching the ✓ symbol.
- 8 Turn the oven off.

Setting the Sabbath mode

- 1 Set the program selector to 🕒.
- 2 Touch the 🕒 symbol.
The suggested value of 24h at 185° F (85° C) appears in the display. Start with ▶
- or -
Change the cooking time and the temperature.

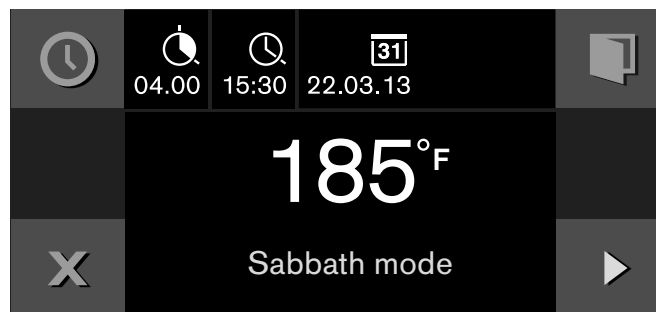

- 3 Changing the cooking time 🕒 :
Touch the 🕒 symbol. Set the preferred cooking time with the rotary selector. You can set up to 74 hours. Confirm by touching the ✓ symbol. Then changing the temperature becomes an option.
- 4 Changing the temperature:
Set the required temperature with the rotary selector.
- 5 Start with ▶ .

The appliance starts. 🕒 and the temperature appear in the display. The Sabbath screen will appear as shown.

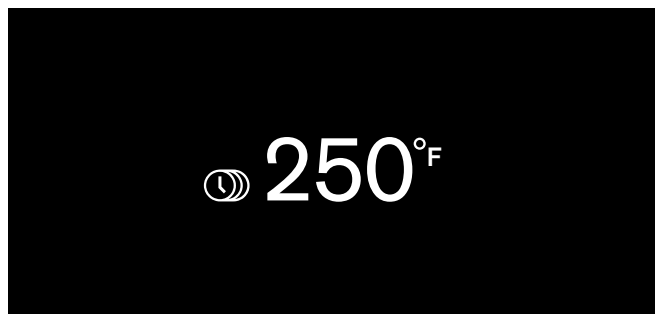

The oven and display lighting is off. The control panel is blocked and no tone can be heard when you touch it.

The appliance no longer heats after expiry of the time. The display is blank. Set the program selector to **0**.

Switching off:

To cancel the operation, set the program selector to **0**.

Yom Tov mode

With this function, the appliance is programmed to perform in three stages.

Stage 1 and 2 can be programmed for a maximum total duration of 74 hours. The duration of Step 3 is 1 hour and cannot be modified.



Stage 1: maintains a warm temperature of 122° F (50° C) in the convection heating function. The interior oven lights remain off through this stage.

Stage 2: the appliance raises to a desired temperature setting and maintains a temperature between 120 and 450° F (50 -230° C). For warming and cooking foods in the convection heating function. The desired time can be adjusted for this stage. The interior oven lights will be on during this time.

Stage 3: maintains a warm temperature of 122° F (50° C) in the convection heating function for 1 hour after stage 2 has ended. The interior oven lights will be on during this time.





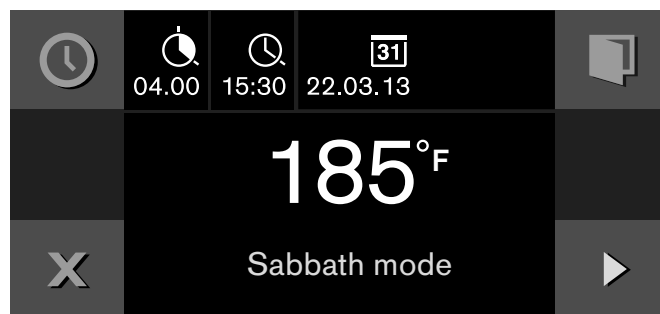

Note that easily perishable foodstuffs must not be left in the oven for too long.

Setting the Yom Tov mode

- 1 Set the program selector to .
- 2 Touch the  symbol.
The suggested value of 24h at 185° F (85° C) appears in the display.



To set Stage 2 cooking time with rotary selector:

- 1 Touch the  symbol to adjust the duration of Stage 2 cooking time .
- 2 Set the desired Stage 2 cooking time with the rotary selector.
- 3 Touch the  symbol to adjust the end of Stage 2 cooking time .
- 4 Select the end time with the rotary selector.
- 5 Change the date if needed by touching the  symbol to .
- 6 Rotate the selector to the desired date.
- 7 Confirm settings by touching the  symbol.

To set Stage 2 temperature:

- 1 Rotate selector to desired Stage 2 temperature.
- 2 Start with .

The temperatures of Stage 1 and Stage 2 appear in the display. The remaining time to the beginning of Stage 2 is counted down in the display. The Yom Tov screen will appear as shown.

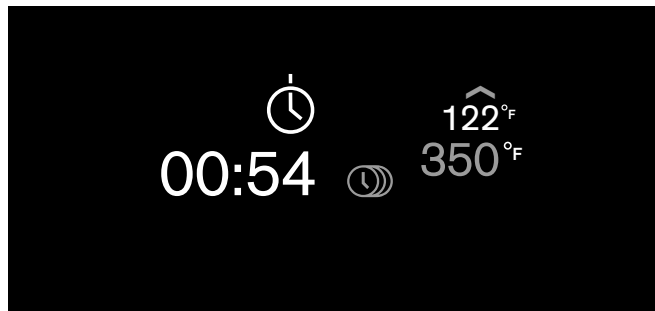

The program will begin with the pre-set warm temperature without light, then advance to the programmed temperature with light until the end of the set date and time, and then maintain the pre-set warm temperature for 60 minutes.

The appliance no longer heats after expiry of the time. The display is blank. Set the program selector to 0.

Switching off:



To cancel the operation, set the program selector to 0.

Personal recipes

You can save up to 50 individual recipes. You can record a recipe. You can assign these recipes a name so that you can fall back on them quickly and conveniently if you need them.

Recording a recipe

You can set up to five phases in succession and you can record them.

- 1 Set the program selection to the required heating function.
The  symbol is displayed.
- 2 Touch the  symbol.
- 3 Choose a free storage location with the rotary selector.
- 4 Touch the  symbol.

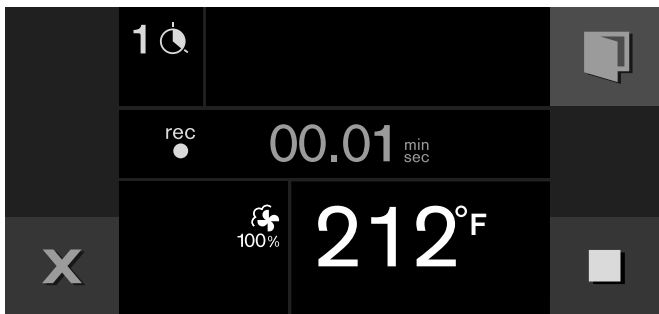



- 5 Set the desired temperature with the rotary selector.
- 6 The cooking time is recorded.
- 7 Recording another phase:
Set the program selection to the required heating function. Set the required temperature with the rotary selector. A new phase begins.
- 8 Once the appliance has achieved the desired cooking result, touch the  symbol to end the recipe.
- 9 Enter the name under "ABC" (see Section entitled *Entering names*).

Notes





- Recording a phase does not begin until the appliance has reached the set temperature.
- Every phase must last at least one minute.
- During the first minute you can change the heating function or the temperature.

Enter the core temperature for a phase:





Insert the core temperature probe in the socket in the oven interior. Set the heating function and temperature. Touch the  symbol. With the rotary selector, enter the required temperature and confirm it with .

Programming a recipe

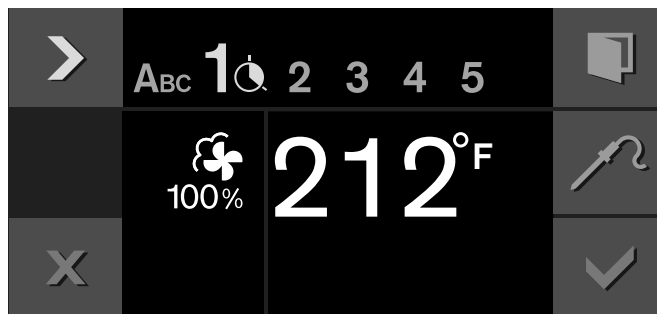

You have the option of programming and saving up to five phases of preparation.

- 1 Set the program selection to the required heating function. Set the required temperature with the rotary selector.
The  symbol is displayed.
- 2 Touch the  symbol.
- 3 Choose a free storage location with the rotary selector..
- 4 Touch the  symbol.
- 5 Enter the name under "ABC" (see Section entitled *Entering names*).
- 6 Choose the first phase with the  symbol.
The heating function and temperature set at the start are displayed. You can change the heating function and temperature with the rotary selectors.



- 7 Choose the time setting with the  symbol.
- 8 Set the required cooking time with the rotary selector.
- 9 Choose the next phase with the  symbol.
- or -
Preparation is complete, end input.
- 10 Save with .
- or -
Cancel with  and quit the menu.

Enter the core temperature for a phase:

Choose the next phase with the  symbol. Set the heating function and temperature. Touch the  symbol. With the rotary selector, enter the required temperature and confirm it with .

Note: For phases for which a core temperature has been programmed you cannot set a cook time.

Entering a name

- 1 Enter the recipe's name under "ABC".

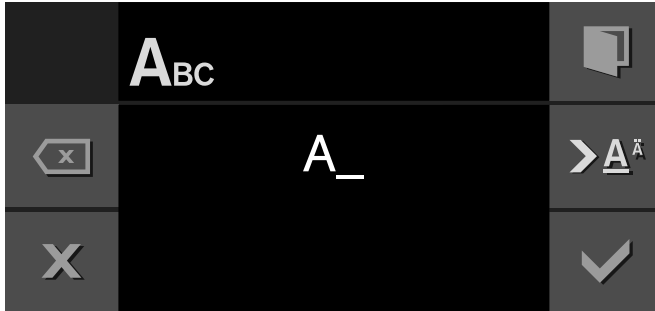

Rotary selector	Selecting letters A new word always begins with an upper case letter.
> A ^á	Press briefly: cursor to the right Press long: switch to diacritics and special characters Press twice: insert line space
> Ä	Press briefly: cursor to the right Press long: switch to normal characters Press twice: insert line space
⊗	Clear letters

- 2 Save with ✓.
- or -
Cancel with X and quit the menu..

Note: For entering a name, Latin characters, certain special characters and numbers are available.

Starting a recipe

- 1 Set the program selection to any heating function. The symbol is displayed.
- 2 Touch the symbol. Set the required recipe with the rotary selector.
- 3 Start with ▶.
Operation begins. Its duration elapses visibly.

The settings of the phases appear in the display bar.

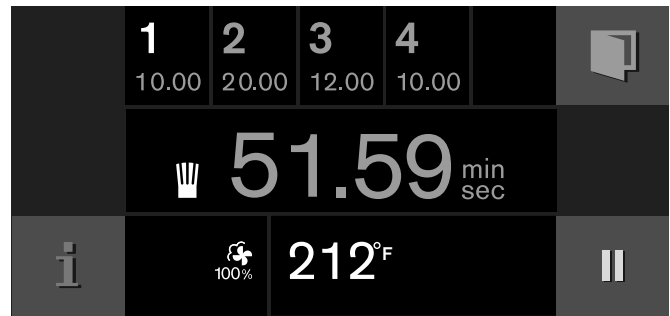

Notes

- The cooking time does not start counting down until the appliance has reached the set temperature.
- You can use the rotary selector to change the temperature while the recipe is in progress. This does not change the saved recipe.

Change recipe

You can change the settings of a recorded or programmed recipe.

- 1 Turn the function selector to any heating type. The symbol is displayed.
- 2 Touch the symbol.
- 3 Use the rotary selector to select the desired recipe.
- 4 Touch the symbol.
- 5 Use the > symbol to select the desired phase. The programmed heating type, temperature, and cooking time are displayed. You can change the settings with the rotary selector or the function selector.
- 6 Save with ✓.
- or -
Cancel with X and exit the menu.

Deleting a recipe

- 1 Set the function selector to any type of heating. The symbol is displayed.
- 2 Touch the symbol.
- 3 Use the rotary selector to select the desired recipe.
- 4 Delete the recipe with C.
- 5 Confirm with ✓.

Core temperature probe

The core temperature probe enables exact cooking to the spot. It measures the temperature inside the food being cooked. Automatic switching off when the desired core temperature is reached ensures that each cooked food is cooked precisely.

Use the included core temperature probe only. You can purchase one as a spare part from after-sales service or in the online shop.

The core temperature probe is damaged at temperatures above 480°F (250°C). Therefore, only ever use it in your appliance at a maximum temperature setting of 445°F (230°C).

Always remove the core temperature probe from the oven interior after use. Never store it in the oven interior.

After every use, clean the core temperature probe with a moist cloth. Do not wash it in a dishwasher!

⚠ WARNING

Risk of electric shock

Use of a wrong core temperature probe can damage the insulation. Use only the core temperature probe intended for this appliance.

⚠ WARNING

Risk of burns

The oven interior and the core temperature probe become very hot. Use oven mitts to plug and unplug the core temperature probe.

Insert the core temperature probe in the food to be cooked

Insert the core temperature probe in the food to be cooked before you place it in the oven interior.

Insert the metal tip at the thickest point in the food you are cooking. Make sure that the end of the tip is approximately in the center. It must not be placed in the fat and must not touch any cookware or bones.



If there are several pieces, insert the core temperature probe in the middle of the thickest piece.

Insert the core temperature probe completely, if possible.

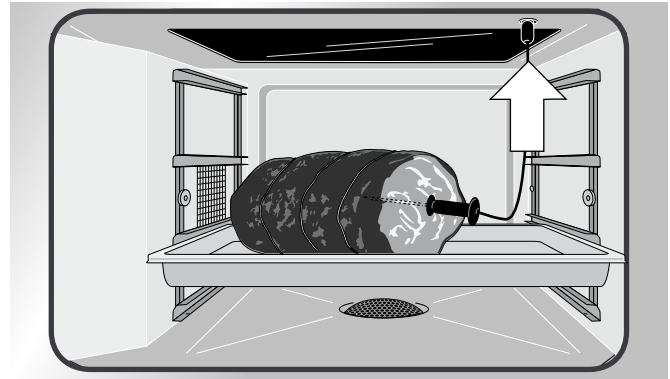
In the case of poultry, make sure that the tip of the core temperature probe is not in the cavity in the center, but in the meat between the belly and upper leg.



Setting the core temperature

- 1 Insert food into the oven interior with the core temperature probe inserted. Insert the core temperature probe in the socket in the oven interior and close the appliance door.
Do not jam the core temperature probe's cable!  and the current core temperature appear in the display.
- 2 Set the program selection to the required heating function.
- 3 Set the oven interior temperature with the rotary selector.
- 4 Touch the  symbol. With the rotary selector, set the required core temperature and confirm it with .
The set core temperature must be higher than the current core temperature.

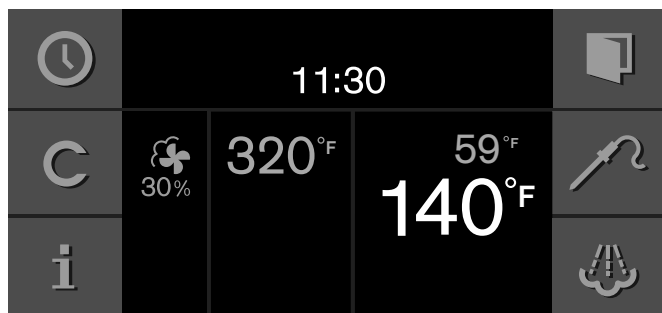



- 5 The appliance heats with the set heating function. The current core temperature is displayed and, under it, the set core temperature. You can change the set core temperature at any time.

A signal sounds when the set core temperature in the food has been reached. The cooking mode is ended automatically. Confirm with  and turn the program selection to 0.

Notes

- The measurable range is 59 to 210° F (15 to 99° C). Outside the measurable range, "--°F" is displayed for the current core temperature.
- If you leave the food in the cooking compartment for some time after cooking, the core temperature will continue to rise somewhat due to the residual heat in the cooking compartment.
- If at the same time you adjust a programming with the core temperature probe and the cooking time timer, then the programming switches the device off that reaches the specified value first.

Changing the core temperature set:

Touch the  symbol. Use the rotary selector to change the set core temperature for the food and confirm with .

Deleting the core temperature set:

Touch the  symbol. Delete the set core temperature with **C**. The appliance continues heating in normal cooking mode.

Recommended core temperature values

Use fresh foodstuffs only. Do not use deep-frozen foods. The details in the table are recommended values. They depend on the quality and condition of foods.

For reasons of hygiene, fish and other critical foodstuffs should have a core temperature of at least 143 - 149 °F (62 - 65 °C) after cooking.

Cooked food	Recommended core temperature
Beef	
Roast beef, fillet of beef, entrecote	
very rare	113 - 117°F (45 - 47 °C)
rare	122 - 126°F (50 - 52 °C)
medium-rare	137 - 140°F (58 - 60 °C)
well-done	158 - 167°F (70 - 75 °C)
Roast beef	176 - 185°F (80 - 85 °C)
Pork	
Roast pork	162 - 176°F (72 - 80 °C)
Back of pork	
medium-rare	149 - 158°F (65 - 70 °C)
well-done	167°F (75 °C)
Meat loaf	185°F (85 °C)
Fillet of pork	149 - 158°F (65 - 70 °C)
Veal	
Roast veal, well-done	167 - 176°F (75 - 80 °C)
Breast of veal, stuffed	167 - 176°F (75 - 80 °C)
Back of veal	
medium-rare	137 - 140°F (58 - 60 °C)
well-done	149 - 158°F (65 - 70 °C)

Cooked food	Recommended core temperature
Fillet of veal	
rare	122 - 126°F (50 - 52 °C)
medium-rare	137 - 140°F (58 - 60 °C)
well-done	158 - 167°F (70 - 75 °C)
Venison	
Saddle of venison	140 - 157°F (60 - 70 °C)
Leg of venison	158 - 167°F (70 - 75 °C)
Venison steak	149 - 158°F (65 - 70 °C)
Rack of hare, rack of rabbit	149 - 158°F (65 - 70 °C)
Poultry	
Chicken	185°F (85 °C)
Guinea fowl	167 - 176°F (75 - 80 °C)
Goose, turkey, duck	176 - 185°F (80 - 85 °C)
Duck breast	
medium-rare	131 - 140°F (55 - 60 °C)
well-done	158 - 176°F (70 - 80 °C)
Ostrich steak	140 - 149°F (60 - 65 °C)
Lamb	
Leg of lamb	
medium-rare	140 - 149°F (60 - 65 °C)
well-done	158 - 176°F (70 - 80 °C)
Saddle of lamb	
medium-rare	131 - 140°F (55 - 60 °C)
well-done	149 - 167°F (65 - 75 °C)
Mutton	
Leg of lamb	
medium-rare	158 - 167°F (70 - 75 °C)
well-done	176 - 185°F (80 - 85 °C)
Saddle of lamb	
medium-rare	158 - 167°F (70 - 75 °C)
well-done	176 °F (80 °C)

Cooked food	Recommended core temperature
Mutton	
Fillet steak	144 - 149°F (62 - 65 °C)
Whole	149°F (65 °C)
Terrine	144 - 149°F (62 - 65 °C)
Miscellaneous	
Bread	194°F (90 °C)
Vol-au-vent	162 - 167°F (72 - 75 °C)
Terrine	140 - 158°F (60 - 70 °C)
Foie gras	113°F (45 °C)

Child lock

The appliance has a child lock to make sure children cannot operate it inadvertently.

Notes

- You must set the child lock in the factory setting to "Available" (see section entitled **Factory setting**).
- If there is a power cut while the child lock is activated, it may be deactivated when the power returns.

Activating the child lock

Requirement:

Program selector is set to 0.

Touch the  symbol for at least 6 seconds.

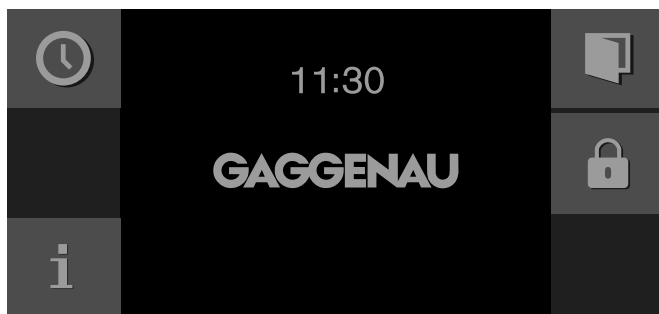

The child lock is activated. The standby screen appears. The  appears at the top of the display.

Deactivating the child lock

Requirement:

Program selector is set to 0.

Touch the  symbol for at least 6 seconds.

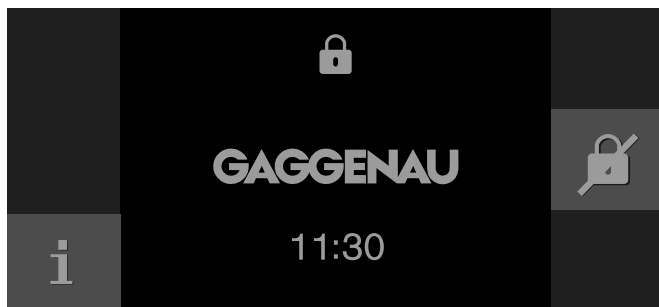

















The child lock is deactivated. You can switch on the appliance in the usual manner.













Factory setting

In the factory settings, you can adapt your appliance individually.

- 1 Set the program selector to **S**.
- 2 Select "Factory setting" with the rotary selector.
- 3 Touch the  symbol.
- 4 Set the required factory setting with the rotary selector.

- 5 Touch the  symbol.
 - 6 Set the factory setting with the rotary selector.
 - 7 Save with  or cancel with  and quit the current factory setting.
 - 8 Turn the program selector to **0** to quit the factory setting menu.
- Changes are saved.

	Basic setting	Possible settings	Explanation
	Brightness	Stages 1, 2, 3, 4, 5*, 6, 7, 8	Setting display brightness
	Standby screen	On*/Off - Clock - Clock + GAGGENAU logo* - Date - Date + GAGGENAU logo - Clock + date - Clock + date + GAGGENAU logo	Appearance of the standby screen. Off: no display. Use this setting to reduce the standby consumption of your appliance. On: several displays can be set, confirm "On" with  and choose the desired display with the rotary selector. The selection is displayed.
	Display screen	Minimized*/Standard	When <i>Minimized</i> is set, only the most important details are displayed after a short time.
	Touchpad color	Gray*/White	Select the color of symbols on the touchpads
	Touchpad tone	Tone 1*/Tone 2/Off	Select the signal tone when touching a touchpad
	Touchpad volume	Levels 1, 2, 3, 4, 5*, 6, 7, 8	Sets the volume of the touchpad tone
	Preheating signal	On*/Off	The signal tone sounds when the required temperature is reached during preheating.
	Signal volume	Levels 1, 2, 3, 4, 5*, 6, 7, 8	Sets the volume of the signal tone
	Water filter	Available* / not available	Available: use appliance with water filter. Not available: use appliance without water filter.
	Water filter capacity	100 - 9000 liters	Set the water filter capacity
	Water hardness	1-18	Check mains water with the included carbon hardness test. Set the measured water hardness.
	Calibration	Calibrating the appliance	Setting the boiling point

	Time format	AM/PM / 24 h*	Time display in 24 or 12-hour format
	Time	Current time	Setting the time
	Daylight savings	Manual*/Automatic	Automatic time changeover when changing daylight savings time. If automatic: setting of the month, day and week when the time is to be changed. To be set separately for summer and winter time.
	Date format	D.M.Y* D/M/Y M/D/Y	Setting the date format
	Date	Current date	Setting the date. Switch between the year/month/day with the ➤ symbol.
	Temperature format	°C*/°F	Set the temperature unit
	Language	German* / French / Italian / Spanish / Portuguese / Dutch / Danish / Swedish / Norwegian / Finnish / Greek / Turkish / Russian / Polish / Czech / Slovenian / Slovakian / Arabic / Hebrew / Japanese / Korean / Thai / Chinese / English US / English	Select language for the text display Note: When the language is changed, the system is restarted; this procedure takes a few seconds. Then the Factory setting menu is closed.
	Factory settings	Restore appliance to factory settings	Confirm the question "Delete all individual settings and restore appliance to factory settings?" with ✓ or cancel with ✕. Note: When restoring factory settings, the individual recipes are also deleted. After restoring the factory settings, you will see the "Initial settings" menu.
	Demo mode	On/Off*	For presentation purposes only. The appliance does not heat in the demo mode, but all other functions are available. The "Off" setting must be activated for normal operation. The setting is only possible in the first three minutes after connecting the appliance.
	Sabbath mode	Not Available* / Available	Available: Sabbath mode can be set; see the section entitled <i>Sabbath mode</i> .
	Door lock	Off*/On	The door lock prevents unintentional opening of the appliance door. When "On" is set, you must touch the  symbol for several seconds before the door opens.
	Child lock	Not Available* / Available	Available: the child lock can be activated (see section entitled <i>Child lock</i>).

* Factory settings

Cleaning and maintenance

If taken care of and cleaned conscientiously, your appliance will stay beautiful and intact for a long time. Here we explain how to take care of and clean your appliance correctly.

WARNING

Risk of burns

The appliance becomes very hot. Never touch the hot inside surfaces of the oven interior or heating elements. Always allow the appliance to cool down. Keep children away.

WARNING

Risk of electrical shock

Moisture entering the appliance can cause an electrical shock. Don't use a high-pressure cleaner or steam cleaner.

WARNING

Risk of injury

Scratched glass in the appliance door can burst. Do not use any glass scrapers or strong or abrasive cleaning agents.

WARNING

Do not clean the appliance while it is still hot. Some cleaners produce noxious fumes when applied to a hot surface. Wet clothes and sponges can cause burns from steam.

Cleaning agents

Pay attention to the information in the table to ensure that the various surfaces are not damaged by incorrect cleaning agents.

Do not use any

- sharp or abrasive cleaning agents
- metal or glass scrapers to clean the glass on the appliance door.
- metal or glass scrapers to clean the door seal.
- hard abrasive pads or cleaning sponges.

Thoroughly rinse out new sponge cloths before use.

Area	Cleaning agent
Door panes	Clean with a dishcloth. Do not use any glass scrapers.
Display	Wipe off with a microfiber cloth and a slightly moistened cloth. Do not wipe it off wet.
Stainless steel	Hot soapy water: clean with a dishcloth and dry with a soft cloth. Remove scale, grease, starch and protein stains immediately. Corrosion can form under such stains. Special stainless steel cleaners are available from after-sales service or specialist dealers.
Aluminum	Clean with a mild window cleaning agent. With a window cleaning cloth or a lint-free microfiber cloth, wipe horizontally over surfaces without applying pressure.
Stainless steel or enamel oven interior	Hot soapy water: clean with a dishcloth and dry with a soft cloth. Do not use oven spray and no other aggressive oven cleaners or abrasive agents. Scourers, rough sponges and pot cleaners are also unsuitable. These scratch the surface. For regular care, use oven interior care agents in compliance with the manufacturer's specification (order number 667027 from after-sales service or in the online shop).
	<hr/> <h3> CAUTION</h3> <p>Cleaner residues will create stains when heated up. Before drying the oven interior, thoroughly remove cleaner or care agent residues with clear water.</p> <hr/>

Always dry the oven interior after cleaning (see Section entitled *Drying program*).

Extremely soiled stainless steel or enamel oven interior	Oven cleaner gel (order number 463582 from after-sales service or in the online shop).
--	--

Please note:

- Must not penetrate into seals on the door, the lamp or the evaporator tray
- Allow it to act for no more than 12 hours.
- Do not use on hot surfaces.
- Rinse thoroughly with water.
- Pay attention to manufacturers' specifications.

Area	Cleaning agent
Ceramic grilling surface (only version with stainless steel interior)	Clean the ceramic grilling surface in the interior regularly with ceramic cleaner (order number 311298 from after-sales service or in the online shop). You can remove baked-in grime with a glass scraper. Make sure you do not scratch the interior.
Glass cover of oven interior lamp	Hot soapy water: Clean with a dishcloth.
Grease filter	Dishwasher
Door seal	Hot soapy water: clean with a dishcloth. Do not scrape. Do not use any metal or glass scrapers for cleaning.
Do not remove!	
Meat probe	Wipe off with a moist cloth. Do not clean in a dishwasher.
Cooking receptacle, rack	Dishwasher or hot soapy solution. Soak baked-in grime and clean with a brush.
Slide-in racks	Dishwasher or hot soapy solution. See Section entitled <i>Removing slide-in racks</i>

Microfiber cloth



The honeycomb-structure microfiber cloth is particularly suitable for cleaning sensitive surfaces such as glass, glass ceramics, stainless steel or aluminum (order No. 460770 available from after-sales service or in the online shop). It removes watery and greasy soiling in one go.

Cleaning aid

The cleaning aid loosens stubborn grime from the oven interior and makes cleaning easy.



The cleaning aid consists of the steps of once cleaning and twice rinsing.

Starting The Cleaning Aid

- 1 Set the function selector to **S**.
- 2 The  symbol is displayed. Confirm with .
- 3 Remove accessories and grease filters from the oven interior. Remove slide-in racks from the oven interior (see section entitled **Removing slide-in racks**). Wipe out the oven interior with cleaner.
- 4 Close the appliance door. Confirm with .

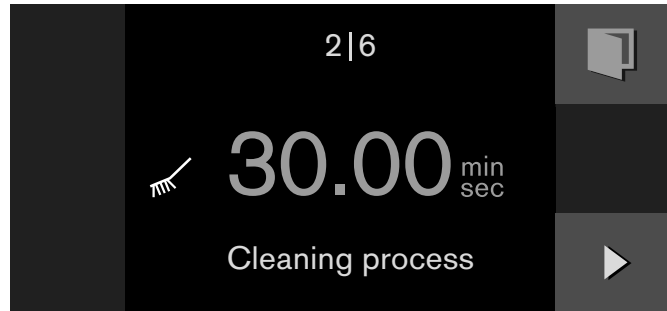
- 5 The cleaning time of 30 minutes appears. Start with . The cleaning time elapses on the display. The lamp in the oven interior stays off.



- 6 A signal sounds after 30 minutes. A message appears in the display.
- 7 Wipe out the oven interior. Remove cleaner residues. Confirm with .
- 8 The rinsing operation appears. Start with . The appliance rinses. The rinsing time elapses on the display.

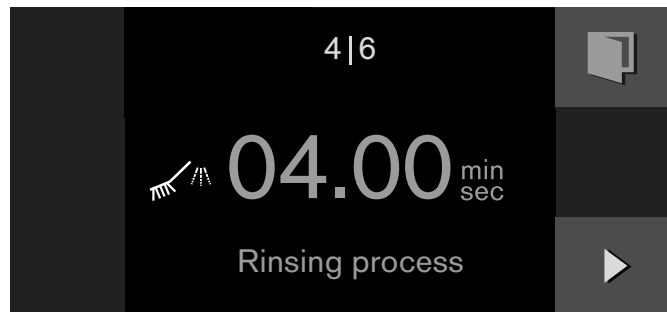

A signal sounds after 4 minutes. Confirm with . Wipe the oven interior dry with a soft cloth and dry it completely with the drying program

Notes



- Always allow the cleaning aid to run fully. It cannot be prematurely.
- Remove cleaning agent residue thoroughly from the oven interior before cooking.
- If the cleaning aid has been canceled due to a power outage, you must restart the cleaning aid before the next use to remove cleaning agent residue from the oven interior.

Drying program

With the drying program, you can dry the cooking compartment after cleaning or after steaming.

The drying program takes 20 minutes.

Starting the drying program

- 1 Remove accessories from the cooking compartment. Wipe out the cooking compartment. Thoroughly remove residues of cleaner. Close appliance door.
- 2 Set the function selector to **S**. Select the drying program with the rotary selector.
- 3 The  symbol is displayed. Confirm with .
- 4 The drying time of 20 minutes appears. Touch  to start. The drying time elapses on the display. The lamp in the cooking compartment stays off.

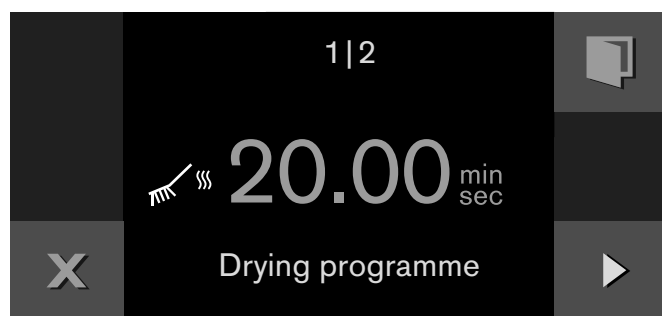

- 5 A signal sounds after 20 minutes. A message appears in the display. Confirm with .

The drying program has ended. Allow the appliance to cool down. Then polish the cooking compartment and the panel with a soft cloth.

Descaling program

To keep your appliance in good working order, you have to descale the cooking compartment regularly. Especially the area behind the side plate should be descaled regularly. Depending on water hardness and frequency of use, you will need to descale your appliance more often, especially for appliance versions with enameled cooking compartments.

Be careful not to scratch the oven interior when removing the side plate. Ensure that no small parts fall into the base strainer. Tip: put a kitchen cloth over the oven base.

Descaler

For descaling, use only the liquid descaler recommended by after-sales service (order # 667025 from after-sales service or in the online shop). Other descaling agents can cause damage to the appliance.

CAUTION

Surface damage

Wipe off descaler immediately with water if it reaches the door seal, the front or other sensitive surfaces.

CAUTION



Surface damage

Do not use harsh or abrasive cleaning agents or objects for descaling.

Notes

- **If using the descaling and neutralizing filter (special accessory GF 111 100):**
clean and descale the cooking compartment each time you change the filter cartridge. If it is not necessary to descale the cooking compartment, clean it with the oven interior care agent.
- We recommend, in combination with the descaler, our oven interior care agent for stainless-steel care and to neutralize descaler residues (order # 667027 from after-sales service or in the online shop). It contains a care agent, a soft non-scratch sponge and a lint-free cloth.

Starting the descaling program

- 1 Set the function selector to **S**. Select the descaling program with the rotary selector.
- 2 The  symbol is displayed. Confirm with . Follow the instructions that are shown in the display.
- 3 To remove the side plate detach the left slide-in rails (see section entitled **Removing slide-in rails**). Detach the grease filter in the upward direction. Undo the forward bolt with a socket wrench (SW 13). Remove the side plate. Confirm with .
- 4 Place the side plate separately in the sink and spray on descaler. Leave to act for a few minutes. Rinse thoroughly with plenty of water.

CAUTION

Do not let the descaling solution come into contact with surfaces that are sensitive to acid (e.g. marble worktops)!

- 5 Spray descaler onto the areas in the cooking compartment where limescale has developed and leave to act for 1 - 3 minutes. Confirm with .
- 6 Repeat the descaling process if necessary.
- 7 Thoroughly rinse off the descaler. Be sure to clean the door seal again with a clean, damp

cloth. Use a spray bottle filled with water and a soft, clean sponge or cloth for rinsing.

⚠ CAUTION

Never heat up the steam oven with descaler or descaling residues in the cooking compartment! This will lead to staining!

- 8 Re-insert the side plate. Re-attach the grease filter and the slide-in rail.
- 9 The rinsing cycle appears. Touch ▶ to start. The appliance rinses. The rinsing time elapses on the display.

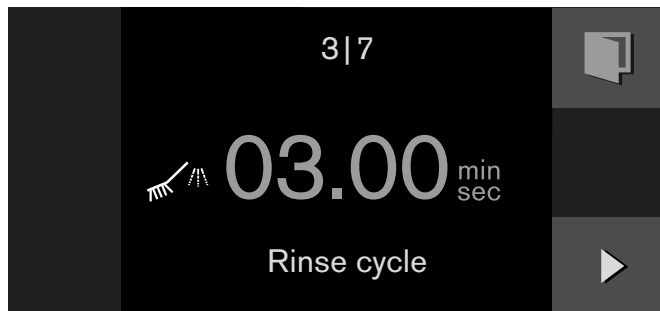

- 10 A signal sounds after 3 minutes. Confirm with ✓. The descaling program has ended. Delete the descaling cue in the display. Confirm with ✓.

Wipe the door seal with a clean, damp cloth. Dry the cooking compartment by wiping it with a soft cloth and dry thoroughly with the drying program.

Removing slide-in racks

You can remove the slide-in racks for cleaning.

Removing slide-in racks

- 1 Place a dishcloth in the oven interior to protect the stainless steel against scratches.
- 2 Undo the knurled nuts (Figure A).
- 3 Pull away the slide-in racks slightly sideward from the screw and pull it out toward you (Figure B).

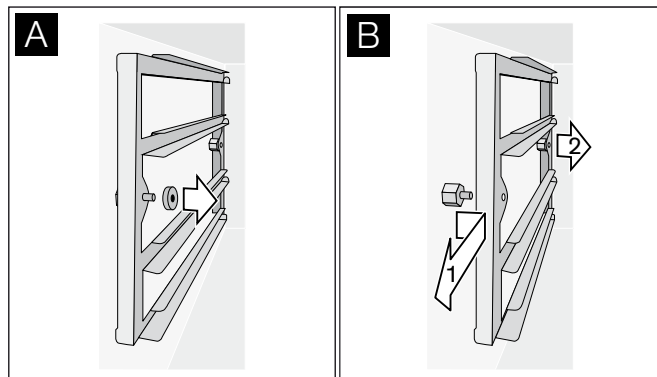

You can clean the slide-in racks in a dishwasher.

Hooking in slide-in racks

- 1 Fit slide-in racks the right way round: they bottom at the back.
- 2 Push the slide-in racks onto the bolt at the rear and then hook them in at the front.
- 3 Tighten the knurled nuts.

Note: If you should lose a knurled nut, you can reorder it as a spare part from our after-sales service. Using knurled nuts other than the original ones will cause corrosion in the oven interior.

Troubleshooting

You can often easily eliminate problems that may occur on your own. Before calling customer service, take into account the following information.

WARNING

Risk of electric shock

Improper repairs are dangerous. Only an after-sales technician trained by us may perform repairs and may replace damaged connecting leads. Remove the mains plug or deactivate the fuse in the fuse box if the appliance is defective. Call after-sales service.

Disruption	Possible cause	Solution
Appliance not working, no display	Plug not inserted	Connect the appliance to the electricity mains
	Power failure	Check whether other kitchen appliances are working
	Fuse defective	Check in the fuse box whether the fuse for the appliance is in working order
	Operating error	Switch off the fuse for the appliance in the fuse box and switch it on again after about 10 seconds
Appliance cannot be started	Appliance door is not quite closed	Close appliance door
Appliance is not working, display is not responding.  appears in the display.	Child lock activated	Deactivate child lock (see section entitled <i>Child lock</i>)
Appliance switches off automatically	Safety deactivation: the appliance has not been operated for longer than 12 hours	Confirm the message with  , switch off the appliance and set it again.
Appliance does not heat up,  appears in the display	Appliance is in the demo mode	Deactivate demo mode in the basic settings
Appliance will not start, a message appears in the display	No water in the appliance	Check water intake
No steam visible	Steam is not visible above 212° F (100°C)	This is normal
Grill heating element is only hot at the edge, not the middle	The grill tray heats only the edges in order to provide optimal heat distribution	This is normal
The  "steam removal" symbol does not appear	You can use the steam removal function only up to a temperature of 130 °C	This is normal
Extreme amounts of steam emerging at the top of the door	Appliance is calibrating the boiling point or is preheating or the mode has been changed	This is normal
	Boiling point has not yet been adjusted	Adjust the boiling point
Extreme amounts of steam emerging at the side of the door	Door seal soiled or loose	Clean the door seal and insert it in the groove
Humming when turned on	Water outlet pump is warming up	Normal operating sound
	Appliance was not used for a few days	Normal: automatic rinsing at start up
There is a 'plop' noise during cooking	Stress expansion in the event of a large temperature difference	This is normal
Appliance does not steam properly any more	Appliance is clogged with scale	Start the descaling program
The cooking compartment is wet after operation	This is normal depending on the operating mode set by the user	After operation, dry the cooking compartment using the drying program

Error message "Exxx"

If an error message appears, turn the program selection to **0**; if the display goes off, it was a one-time problem. If the problem occurs repeatedly or if the display stops, please contact after-sales service and inform them of the error code.

Power cut

Your appliance can bridge a power cut of a few seconds. Operation continues.

If the power cut was for a longer period and the appliance was in operation, a message appears in the display. Operation is interrupted.

Set the function selector to **0**, then the appliance can be operated again as usual.

Demo mode

The demo mode is activated if the  symbol appears in the display. The appliance does not heat up.

Briefly disconnect the appliance from the mains (switch off the domestic fuse or the circuit-breaker in the fuse box). Then deactivate the demo mode within 3 minutes in the factory setting (see section entitled **Factory setting**).

Replacing the oven interior lamp

For technical reasons, the lamp cover is not detachable. Only Gaggenau after-sales service may replace the lamp.



CAUTION

Do not detach the lamp cover. This would damage the seal.

The lamp cover in the oven must be replaced if it is damaged. You can obtain covers from after-sales service. Always specify the E number and the FD number of your appliance.

Customer service

If your appliance needs repairs, our customer service is there for you. We work hard to help solve problems quickly and without unnecessary service calls, getting your appliance back up and running correctly in the least amount of time possible.

When you call, please indicate the product number (E-Nr.) and serial number (FD-Nr.) so that we can support you in a qualified manner. You will find the type plate with these numbers on the bottom of the appliance. To avoid having to search for a long time when you need it, you can enter your appliance data and the customer support telephone number here.

E-Nr.

FD-Nr.

Customer Service 

Please read the use and care instructions provided with your appliance. Failure to do so may result in an error in using the appliance. This could result in a service call that instead of fixing a mechanical issue is only needed for customer education. Such calls are not covered by the appliance warranty.

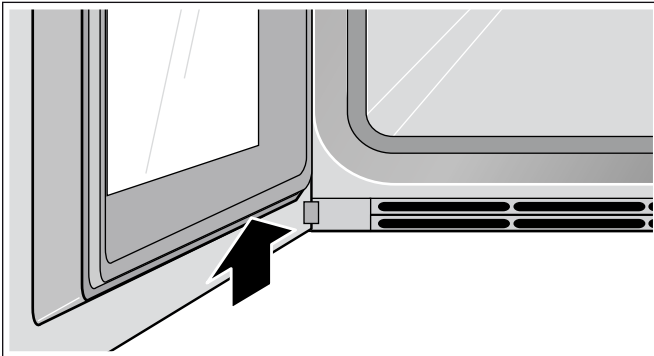

Please find the contact data of all countries in the enclosed customer service list.

To book an engineer visit and product advice

USA 877 442 4436
 toll-free

CANADA 800 828 9165

You can rely on the manufacturer's expertise. Rest assured that the repair will be handled by trained service technicians who have the original replacement parts for your appliance.

Tables and tips

Notes

- The cooking times specified are intended as a guide. The actual cooking time depends on the quality and temperature of the food before cooking, the weight and thickness of the food to be cooked.
- Always preheat the appliance. Here's how to get the best cooking results.
The cooking times specified refer to a pre-heated appliance. Cook the food approx. 5 minutes longer if the appliance is not pre-heated.
- The specifications refer to average quantities for four people. If you would like to prepare more, you should calculate a longer cooking time.
- Use the cookware specified. If you use other cookware, cooking times may be longer or shorter.
- Begin with the shortest time specified if you have not made a dish before. If necessary, you can always cook the food longer.
- Make sure to open the cooking compartment door of the pre-heated appliance only briefly and to fill the appliance quickly.
- If you are using only one cooking container, insert it on the second level from the bottom.
- When steaming, defrosting, proofing dough, and reheating, you can use up to three slide-in levels at the same time (slide-in levels 2, 3, and 4 from the bottom). This way there is no taste transfer. This is how fish, vegetables, and dessert can be prepared at the same time. The cooking times specified may be longer with a large quantity of food.
- Baking can only be done on one level; for this, use the second level from the bottom.
- Do not allow the food to touch the cooking compartment, grease filter or back wall of the oven.
- The steam baking oven door must close securely. Always keep the sealing surfaces clean.
- Do not crowd the grid and containers too tightly. This guarantees optimal steam circulation.
- Leave the grease filter in the appliance at all times.
- If you want to prepare dishes in steam and the appliance is hotter than 100°C (e.g. because something was baked in it previously), let the appliance cool off before steaming. Otherwise the dishes will dry out due to the excessive heat.

Vegetables

- Vegetables are prepared more gently in steam than in boiling water. Their taste, color and consistency are preserved better. Vitamins and ingredients that are soluble in water are hardly washed out. As the steam oven operates without pressure at only 212 °F (100°C), foods are prepared considerably more gently than in a pressure cooker, for example.
- All data refers to 1 kg (about 2 lb) of cleaned vegetables.
- Use the perforated cooking insert to steam vegetables, sliding it into the second level from below. Slide the unperforated cooking insert under it. You can use collect the vegetable juice and use it as the basis for a sauce or a vegetable broth.
- Blanch vegetables for up to four minutes in the preheated appliance. If vegetables or fruits are not served straight away, quench them in icy water to prevent simmering in the residual heat.

Foodstuff	Cooking receptacle	Temperature in °F (°C)	Humidity in %	Cooking time in min.	Remarks
Artichokes, large	Perforated	212 (100)	100	25 - 35	
Artichokes, small	Perforated	212 (100)	100	15 - 20	
Cauliflower, whole	Perforated	212 (100)	100	20 - 25	
Cauliflower, in florets	Perforated	212 (100)	100	15 - 20	
Beans, green	Perforated	212 (100)	100	25 - 30	
Broccoli, in florets	Perforated	212 (100)	100	10 - 15	
Fennel, in strips	Perforated	212 (100)	100	10 - 15	

Foodstuff	Cooking receptacle	Temperature in °F (°C)	Humidity in %	Cooking time in min.	Remarks
Vegetable terrine	Perforated/rack	212 (100)	100	40 - 50	In a terrine form
Carrots, in slices	Perforated	212 (100)	100	10 - 15	
Potatoes, peeled and quartered	Perforated	212 (100)	100	20 - 35	
Kohlrabi, in slices	Perforated	212 (100)	100	15 - 25	
Leek, in slices	Perforated	212 (100)	100	5 - 10	
Bell pepper, filled	Unperforated	355 - 390 (180 - 200)	80/100	15 - 20	If there is a meat filling, brown the filling beforehand.
Jacket potatoes (about 50 g (approx. 1.8 oz) each)	Perforated	212 (100)	100	25 - 30	
Jacket potatoes (about 100 g (approx. 3.5 oz) each)	Perforated	212 (100)	100	40 - 45	
Brussels sprouts	Perforated	212 (100)	100	15 - 20	
Asparagus, green	Perforated	212 (100)	100	10 - 15	
Asparagus, white	Perforated	212 (100)	100	18 - 25	
Spinach	Perforated	212 (100)	100	4	
Tomatoes, skinned	Perforated	212 (100)	100	3 - 4	Cut into tomatoes and quench them with icy water after steaming.
Sugar snaps	Perforated	212 (100)	100	5 - 10	

Fish

- Steaming does not dry out fish and its intrinsic taste and texture are preserved very well.
- For reasons of hygiene, fish and other critical foodstuffs should have a core temperature of at least 143 - 149° F (62 - 65°C) after cooking. This is simultaneously the ideal cooking point.
- Do not salt fish until after cooking it. This preserves the natural aroma and less water is extracted from the fish.
- When using the perforated cooking receptacle: you can grease it lightly if fish should stick to it too easily.
- Insert the unperforated cooking insert in the first level from below to avoid extreme soiling of the oven interior with intensively smelling fish juice.
- In the case of fillets with skin: place the fish with its skin side pointing upward to preserve its structure and aroma.

Foodstuff	Cooking receptacle	Temperature in °F (°C)	Humidity in %	Cooking time in min.	Remarks
Gilthead, whole (700 g/24 oz)	Unperforated	195 - 212 (90 - 100)	100	20 - 25	
Fish dumplings (20 - 40 g/0.7 - 1.4 oz)	Unperforated	195 - 212 (90 - 100)	100	5 - 10	Line the unperforated cooking receptacle with parchment paper
Lobster, cooked, peeled, regenerating	Perforated	160 - 175 (70 - 80)	100	10 - 12	
Carp, blue, whole (1.5 kg/3.5 lb)	Unperforated	195 - 212 (90 - 100)	100	40 - 50	in juice
Salmon fillet (300 g/10.5 oz each)	Perforated	195 - 212 (90 - 100)	100	12 - 15	
Salmon, whole (2.5 kg/5.5 lb)	Perforated	212 (100)	100	70 - 80	
Mussels (1.5 kg/3.5 lb)	Perforated	212 (100)	100	8 - 12	The mussels are done once the shells have opened.

Foodstuff	Cooking receptacle	Temperature in °F (°C)	Humidity in %	Cooking time in min.	Remarks
Pollock, whole (800 g/1.8 lb)	Perforated	195 - 212 (90 - 100)	100	20 - 25	
Fillet of monkfish (300 g/10.5 oz each)	Glass form/rack	355 - 390 (180 - 200)	100	10 - 12	in juice
Sea bass, whole (400 g/0.9 lb)	Perforated	195 - 212 (90 - 100)	100	15 - 20	

Fish – low-temperature steaming

- When steamed at between 70 and 90°C (approx. 160 and 190 °F), fish does not overcook and fall apart so easily. This is particularly advantageous for sensitive fish.
- The data for the various fish types refers to fillets.
- Insert the unperforated cooking insert in the first level from below to avoid extreme soiling of the oven interior with intensively smelling fish juice.
- Serve on preheated cookware.

Foodstuff	Cooking receptacle	Temperature in °F (°C)	Humidity in %	Cooking time in min.	Remarks
Oysters (10 oysters)	Unperforated	180 - 190 (80 - 90)	100	2 - 5	in juice
Tilapia (150 g/5.3 oz each)	Perforated	180 - 190 (80 - 90)	100	10 - 12	
Gilthead (200 g/7 oz each)	Perforated	180 - 190 (80 - 90)	100	12 - 15	
Fish fillet (200 - 300 g/7-11 oz each)	perforated	180 - 190 (80 - 90)	100	12 - 15	
Fish terrine	Rack	160 - 180 (70 - 80)	100	50 - 90	in terrine form
Trout, whole (250 g/8.8 oz each)	Perforated	180 - 190 (80 - 90)	100	12 - 15	
Halibut (300 g/11 oz each)	Perforated	180 - 190 (80 - 90)	100	12 - 15	
Scallops (6 scallops)	Unperforated	180 - 190 (80 - 90)	100	4 - 8	
Cod (250 g/8.8 oz each)	Perforated	180 - 190 (80 - 90)	100	10 - 12	
Red snapper (200 g/0.44 oz each)	Perforated	180 - 190 (80 - 90)	100	12 - 15	
Redfish (120 g/0.3 oz each)	Perforated	180 - 190 (80 - 90)	100	10 - 12	
Monkfish (200 g/0.44 oz each)	Perforated	180 - 190 (80 - 90)	100	10 - 15	
Rolled sole fillets (150 g/0.33 oz each)	Perforated	180 - 190 (80 - 90)	100	12 - 15	
Turbot (300 g/0.66 oz each)	Perforated	180 - 190 (80 - 90)	100	12 - 15	
Sea bass (150 g/0.33 oz each)	Perforated	180 - 190 (80 - 90)	100	10 - 12	
Zander (250 g/8.8 oz each)	Perforated	180 - 190 (80 - 90)	100	12 - 15	

Meat – cooking at higher temperatures







- The combination of steam and hot air is the optimum cooking process for many types of meats. In this mode of operation, the oven compartment is sealed hermetically and moisture prevents the drying-out effect of the conventional hot air. Thanks to variable humidity control, you can achieve the optimum climate for every food.
- The cooking times specified serve to help you orientate yourself and depend very much on the initial temperature of the food and the length of time it is browned. Use the core temperature probe for better control. You will find notes and optimum target temperatures in the section entitled **Core temperature probe**.
- Take meat out of the fridge one hour before preparing it.
- When using the perforated cooking inserts or the rack, place an unperforated cooking receptacle beneath it. Pour some water into the unperforated cooking insert to prevent baking in. You can also insert vegetables, wine, spices and herbs to arrive at a tasty basis for sauces.
- If you would like to cook meat rare or medium-rare: open the door 5 °C (approx. 40 °F) before the required core temperature has been reached and wait until the target temperature is reached. This prevents overcooking and you give the meat the time it needs to settle.
- Letting meat settle: let the meat settle for another 10-15 minutes after cooking. In this way, the meat can "relax". Circulation of the meat juice diminishes and there are fewer losses of juice when cutting open the meat.

Foodstuff	Cooking receptacle	Temperature in ° F (° C)	Humidity in %	Cooking time in min.	Remarks
Entrecote, browned, medium-rare (350 g/12 oz each)	Unperforated	340 - 355 (170 - 180)	0/30	10 - 20	
Filet, browned, medium-rare, in puff pastry (600 g/21 oz)	Unperforated	355 - 390 (180 - 200)	80/100	30 - 45	Line the cooking receptacle with baking paper
Back of veal, browned, medium-rare (1 kg/2 lb)	Unperforated	320 - 355 (160 - 180)	30/60	20 - 30	30 % humidity is sufficient when liquid is added to the unperforated cooking receptacle.
Smoked pork chops, cooked, in slices	Unperforated	212 (100)	100	15 - 20	
Roast pork with crust, well-done (1.5 kg/3.5 lb)	Rack	1) 250 (120)	100	30	Cut into the crust crosswise before cooking. Use the core temperature probe: in the second cooking step, you should achieve a core temperature of about 65 °C (approx. 150 °F) to cook the meat in the third step up to a core temperature of 75 - 80 °C (approx. 170 - 180 °F).
		2) 300 - 320 (150 - 160)	60 - 80	25 - 40	
		3) 430 - 445 (220 - 230)	0	15 - 30	
Leg of lamb, browned, medium-rare (1.5 kg/3.5 lb)	Unperforated	340 - 355 (170 - 180)	30/60	60 - 80	
Back of venison, browned, medium-rare (500 g/18 oz each)	Unperforated	320 - 355 (160 - 180)	0/30	12 - 18	
Beef roast, well-done (1.5 kg /3.5 lb)	Rack	1) 410 - 445 (210 - 230)	100	15 - 20	30 % humidity is sufficient when liquid is added to the unperforated cooking receptacle.
		2) 285 - 320 (140 - 160)	30/60	60 - 90	
Roast beef, browned, medium-rare (1 kg/2 lb)	Unperforated	320 - 355 (160 - 180)	0/30	40 - 60	

Foodstuff	Cooking receptacle	Temperature in ° F (° C)	Humidity in %	Cooking time in min.	Remarks
Roast pork (neck or shoulder), well-done (1.5 kg/3.5 lb)	Rack	1) 430 - 445 (220 - 230) 2) 320 - 340 (160 - 170)	100 30 / 60	10 60 - 90	30 % humidity is sufficient when liquid is added to the unperforated cooking receptacle.
Heating up (boiled) sausage	Unperforated	185 - 195 (85 - 90)	100	10 - 20	e.g. Bavarian veal sausage ('Weisswurst') or 'Lyoner' pork sausage

Meat/poultry – slow cooking

- Vigorously browned meat matures over a longer time at a lower temperature. As a result, the meat evenly becomes gentle pink and extraordinarily juicy apart from a very thin edge. And it is neither necessary to turn the meat nor pour juice over it.
- The cooking times specified are only a recommendation and depend very much on the initial temperature of the food and the length of time it is browned. Use the core temperature sensor for better control. You will find notes and optimum target temperatures in the section entitled **Core temperature sensor**.
- Take meat out of the fridge one hour before preparing it.
- For hygienic reasons, sear the meat briefly at a high temperature in the pan from all sides before cooking it. As a result, a crust is produced that prevents leaking of the meat juice and ensures a typical roast aroma.
- Season carefully: slow maturing of the meat boosts all aromas.
- Game tastes stronger after low-temperature cooking than when prepared by classical methods.
- Use the "Slow cooking" mode . The moisture escaping from the food stays in the cooking compartment and prevents drying out of prepared foods.
- Please note that you cannot achieve any core temperatures above the cooking compartment's temperature. As a rule of thumb: the set oven temperature should be 50 - 60 °F (10-15 °C) above the desired core temperature.
- You can reduce the temperature to 140 °F (60 °C) towards the end of the cooking time. Thus, you can prolong the cooking time (for example, if guests arrive late). If you want to stop the cooking process, the interior temperature must not be higher than the desired core temperature. Thus, large pieces can stay in the oven for 1 - 1.5 hours, while small pieces can stay there for 30 - 45 minutes.
- Serve food on preheated cookware.

Foodstuff	Cooking receptacle	Temperature in ° F (° C)	Heating mode	Cook time in min.	Remarks
Duck breast, medium rare (approx. 350 g)	Unperforated	160 - 175 (70 - 80)		40 - 60	
Rib-eye, medium rare (approx. 350 g)	Unperforated	160 - 175 (70 - 80)		40 - 70	
Leg of lamb, boneless, tied, medium rare (1.5 kg)	Unperforated	160 - 175 (70 - 80)		180 - 240	
Roast beef, medium rare (1 - 1.5 kg)	Unperforated	160 - 175 (70 - 80)		150 - 210	
Pork medallions, well done (approx. 70 g)	Unperforated	175 (80)		50 - 70	
Steak, medium rare (approx. 200 g)	Unperforated	160 - 175 (70 - 80)		30 - 60	

Poultry

- The humidity during combined operation prevents drying out which, especially in the case of poultry, is crucial. At the same time, the high temperature lends crispy browning to the surface. The heat transmitted by the hot steam is twice as high as in the case of conventional hot air and it reaches all parts of the food. This is why a chicken becomes browned and crispy all-round, and nevertheless the breast meat stays tender and juicy.
- The cooking times specified serve to help you orientate yourself and depend very much on the initial temperature of the food. Use the core temperature probe for better control. Do not place it in the middle (cavity), but between the belly and the thigh. You will find further notes and optimum target temperatures in the section entitled **Core temperature probe**.
- If you season poultry mainly with spices and with little or no oil, the skin will become crispier.

Foodstuff	Cooking receptacle	Temperature in °F (°C)	Humidity in %	Cooking time in min.	Remarks
Duck, whole (3 kg/6.6 lb)	Unperforated	1) 300 - 320 (150 - 160) 2) 430 (220)	60 0	80 - 90 20 - 30	Start cooking with the breast pointing down. Turn the duck round after half of the cooking time. In this way, the sensitive breast meat will not dry out so much.
Duck breast, browned, medium-rare (350 g/12 oz each)	Unperforated	320 - 355 (160 - 180)	0	8 - 15	
Chicken, whole (1.5 kg/3.3 lb)	Rack	1) 340 - 355 (170 - 180) 2) 365 (185)	60 0	30 - 45 15 - 20	
Chicken breast, stuffed, steamed (200 g/7 oz each)	Perforated	212 (100)	100	10 - 15	
Turkey breast fillet, steamed (300 g/11 oz) each	Perforated	212 (100)	100	12 - 15	
Spring chicken, quail, pigeon (300 g/11 oz each)	Perforated	212 (100)	100	25 - 30	
Spring chicken, quail, pigeon (300 g/11 oz each)	Perforated	355 - 390 (180 - 200)	60/80	12 - 16	

Grilling

- Use the different grilling modes to further brown dishes.
- Insert the dish on levels 1 to 3 (from below) when grilling.
- Use the different levels for the desired grilling effect. On level 1 from below the grilling effect will be lighter, on level 3 it will be stronger.
- If the result is not strong enough you can move the dish up to level 2 in the grilling mode.
- Preheat the oven for no more than 5 minutes when grilling or grilling with hot air since after 5 minutes the required temperature has been reached.
- Do not use the core temperature probe when grilling, grilling with hot air and grilling with humidity.

Foodstuff	Cooking receptacle	Temperature in °F (°C)	Heating mode	Cook time in min.	Shelf position
Potato gratin	Unperforated	355 (180)	Full surface grill level 1 + humidity	35 - 40	1/2/3
Vegetable casserole	Unperforated	355 (180)	Full surface grill level 1 + humidity	35 - 40	1/2/3
Zucchini gratin, stuffed and halved	Unperforated	355 (180)	Full surface grill level 2+ humidity	17 - 23	2
Grilled vegetables (e.g. zucchini, eggplant)	Unperforated	445 (230)	Full surface grill	15	3
Vegetable skewers	Wire rack + unperforated	445 (230)	Full surface grill / full surface grill + circulated air	12 - 14 per page	3
Toast with topping	Wire rack + unperforated	390 (200)	Full surface grill	12 - 14	2/3
Toast	Wire rack	445 (230)	Full surface grill + circulated air / full surface grill	2 - 3	2/3
Chicken drumsticks	Wire rack + unperforated	355 - 390 (180 - 200)	Full surface grill level 2+ humidity	35 - 40	2/3
Baiser on a cake	Springform pan	445 (230)	Full surface grill	5 - 6	2
Scampi skewers	Wire rack + unperforated	445 (230)	Full surface grill + circulated air	3 - 5	3
Trout (whole)	Wire rack + unperforated	445 (230)	Full surface grill	10 - 12 per page	3

Side dishes

Also pay attention to the information on the packaging.

Foodstuff	Cooking receptacle	Temperature in °F (°C)	Humidity in %	Cooking time in min.	Remarks
Basmati rice (250 g + 500 ml or 9 oz + 1 pint of water)	Unperforated	212 (100)	100	20 - 25	
Couscous (250 g + 250 ml or 9 oz + ½ pint of water)	Unperforated	212 (100)	100	5 - 10	
Au gratin potatoes (1.5 kg/3.5 lb of potatoes)	Unperforated	355 - 390 (180 - 200)	0/30	35 - 50	
Dumplings (90 g/ 3.2 oz each)	Perforated/ unperforated	205 - 212 (95 - 100)	100	20 - 25	
Long grain rice (250 g + 500 ml or 9 oz + 1 pint of water)	Unperforated	212 (100)	100	25 - 30	
Rice (250 g + 375 ml or 9 oz + 0.8 pint of water)	Unperforated	212 (100)	100	30 - 40	
Tellerlinsen (German lentils) (250 g + 500 ml or 9 oz + 1 pint of water)	Unperforated	212 (100)	100	25 - 35	
Pastries, fresh, cooled	Perforated	212 (100)	100	5 - 7	
Pastries, filled, fresh, cooled	Perforated	212 (100)	100	7 - 10	
White beans, pre-soaked (250 g + 1 l or 9 oz + 2 pints of water)	Unperforated	212 (100)	100	55 - 65	





Desserts

Foodstuff	Cooking receptacle	Temperature in °F (°C)	Humidity in %	Cooking time in min.	Remarks
Crème brûlée (130 g/4.5 oz each)	Perforated	195 - 205 (90 - 95)	100	35 - 40	in ramekins, covered with heat-resistant transparent film
Yeast dumplings (100 g /3.5 oz each)	Unperforated	212 (100)	100	20 - 30	Leave yeast dumplings to rise for 30 min. before steaming (see section entitled <i>Dough proofing</i>).
Flan/crème caramel (130 g /4.5 oz each)	Perforated	195 - 205 (90 - 95)	100	25 - 30	in ramekins, covered with heat-resistant transparent film
Compote	Unperforated	212 (100)	100	5 - 15	e.g. apples, pears, rhubarb Add sugar, vanilla sugar, cinnamon or lemon juice to taste.
Rice pudding (250 g/9 oz of rice + 625 ml/1.3 pint of milk)	Unperforated	212 (100)	100	35 - 45	Add fruits, sugar or cinnamon to taste.
Sweet soufflé	Unperforated	355 - 390 (180 - 200)	0/60	20 - 40	e.g. semolina, curd cheese or precooked rice pudding

Other

Foodstuff	Cooking receptacle	Temperature in °F (°C)	Humidity in %	Cooking time in min.	Remarks
Disinfecting (e.g. baby bottles, jelly jars)	Rack	212 (100)	100	20 - 25	
Desiccating/drying fruit or vegetables	Perforated	175 - 210 (80 - 100)	0	180 - 300	e.g. tomatoes, mushrooms, zucchini, apples, pears, etc. in thin slices
Eggs, size M (5 eggs)	Perforated	212 (100)	100	8 - 15	
Royal (500 g/1 lb)	Glass mold, rack	195 (90)	80 - 100	25 - 30	Cover with heat-resistant transparent film
'Griessnockerl' (semolina dumplings)	Unperforated	195 - 205 (90 - 95)	100	8 - 10	
Lasagne	Unperforated	340 - 375 (170 - 190)	0 / 60	35 - 60	
Soufflé	Ramekin, rack	355 - 390 (180 - 200)	60	12 - 20	

Cakes and cookies

- Using the steam oven, you can prepare your baked items with the optimum humidity:
 -  | Convection + 0% Humidity: moisture can escape in the case of fruit cakes and quiche. This mode corresponds to hot air in the conventional oven.
 -  | Convection + 30% Humidity: mixed cake does not dry out. The intrinsic humidity in a food cannot escape from the oven interior.
 -  | Convection + 60 - 100% Humidity: puff pastry and yeast-risen pastries become looser on the inside and crispy on the outside with a gloss.
- You can only bake on one level in the steam oven. Insert the unperforated cooking container into the second level from below. When using a high baking tin, place it on the wire rack, which you then insert in the first level from below.
- Always leave the grease filter in place when baking.
- Misting brings additional steam to the food during baking with Convection + 0% Humidity or with Convection + 30% Humidity when touching the  symbol. Use the misting function for example when baking bread at the beginning of the baking time and the bread will increase in volume and will get a crispy crust.

Foodstuff	Cooking receptacle	Temperature in °F (°C)	Humidity in %	Cooking time in min.	Remarks
Apple pie	20 cm spring-form tin, rack	330 - 350 (165 - 175)	0	70 - 80	
Bagels	Unperforated	375 - 410 (190 - 210)	80 - 100	20 - 25	
Baguette, prebaked	Rack	375 - 390 (190 - 200)	0 - 80	10 - 15	
Sponge cake base, high (6 eggs)	Springform	320 - 340 (160 - 170)	0	30 - 35	
Jelly roll (2 eggs)	Unperforated	375 - 410 (190 - 210)	0 - 30	8 - 11	
Small flaky pastry cakes and cookies	Unperforated	375 - 410 (190 - 210)	80 - 100	12 - 20	

Foodstuff	Cooking receptacle	Temperature in °F (°C)	Humidity in %	Cooking time in min.	Remarks
Bread rolls (50 - 100 g each - approx. 1.8 - 3.5 oz.)	Unperforated	355 - 390 (180 - 200)	80 - 100	15 - 25	You can bake bread rolls very well as follows: Preheat to 430°F (220°C) with 30 % humidity. After placing your items for baking in the appliance, steam once to twice and switch back to 0 % and 375°F (190°C) after 5 minutes.
Bread rolls, prebaked	Rack	300 - 340 (150 - 170)	0	8 - 15	Steam initially
Bread (1 - 1.5 kg)	Unperforated	1) 410 - 445 (210 - 230) 2) 330 (165)	30 0	15 - 20 35 - 50	Steam 2 - 3 times at the beginning
Flat cake made out of cake mixture	Unperforated	320 - 345 (160 - 175)	0	25 - 40	
Bundt cake	Bundt pan, rack	320 - 345 (160 - 175)	30 - 60	35 - 45	Yeast dough from 1 kg (approx. 2 lb) of flour
Yeast tray bake	Unperforated	320 - 340 (160 - 170)	0 - 60	30 - 45	Use 0 % humidity for yeast tray bakes with a moist topping (e.g. plum cake or onion tart) and 60 % humidity for a dry topping (e.g. crumble).
'Hefezopf' (500 g / approx. 1 lb of flour)	Unperforated	320 - 340 (160 - 170)	60 - 80	25 - 35	
Muffins	Muffin tray, rack	340 - 355 (170 - 180)	0 - 30	20 - 30	
Macaroons	Unperforated	300 - 320 (150 - 160)	0	15 - 20	
Cookies	Unperforated	300 - 350 (150 - 175)	0	10 - 20	
Quiche, tart	Quiche form, rack	375 - 410 (190 - 210)	0	45 - 60	
Mixed cake	Cake tin/ springform, rack	320 - 345 (160 - 175)	0 - 30	50 - 60	
Small cakes	Unperforated	300 - 320 (150 - 160)	0	35 - 45	
Cookies	Unperforated	300 - 320 (150 - 160)	0	25 - 30	
Tarte	Tart form, rack	375 - 410 (190 - 210)	0 - 30	30 - 45	
Cream puffs, eclairs	Unperforated	355 - 375 (180 - 190)	0 - 30	40 - 45	

Regenerating (warming up)

- In the steam oven, you can generate the optimum climate for warming ready-cooked meals without them drying out. Thus, taste and quality are preserved, and meals taste like freshly prepared.
- Use the "Regenerating" mode  to do this.
- The data refers to portions for one person. You can also warm up large quantities in the unperforated cooking insert. The specified times are lengthened.

Foodstuff	Cooking receptacle	Temperature in °F (°C)	Cooking time in min.	Remarks
Baguette, bread rolls (frozen)	Rack	285 (140)	8 - 12	
Baguette, bread rolls (from the day before)	Rack	355 (180)	4 - 8	
Vegetables	Plate, rack	195 - 212 (90 - 100)	7 - 10	
Starch-based side dishes	Plate, rack	250 (120)	7 - 10	e.g. noodles, potatoes, rice; baked or deep fried foods such as french fries or croquettes are not suitable
Plated meals	Plate, rack	250 (120)	8 - 15	
Pizza, thick	Rack	355 (180)	8 - 10	
Pizza, thin	Rack	355 (180)	4 - 6	

Raising dough

- The steam oven offers the ideal climate for raising dough and dough mixtures or dough pieces without drying them out.
- Use the "Dough proofing" mode  to do this.
- The bowl need not be covered with a moist cloth. Raising only takes half as much as it used to.
- The specified dough proofing time is for your orientation only. Raise dough until its volume has doubled.

Foodstuff	Cooking receptacle	Temperature in °F (°C)	Cooking time in min.	Remarks
Dough mixture	Bowl/rack	100 (38)	25 - 45	e.g. yeast dough, self-raising flour and sour dough

Thawing







- In the steam oven you can gently and evenly thaw deep frozen foods faster than at room temperature.
- Use the "Defrosting" mode * to do this.
- The specified thawing times are for your orientation only. The time it takes to thaw depends on the size and weight of the frozen food: freeze your foods flatly or individually. This shortens the thawing time.
- Take foods out of the packaging before thawing them.
- Thaw only the amount you immediately need.
- Remember: in certain circumstances, thawed food does not keep so well and goes bad faster than fresh food. Immediately process thawed food and cook it thoroughly.
- After half of the thawing time, turn meat or fish over fish or separate fragmentary frozen food

such as berries or bits of meat. Fish need not thaw fully. It suffices if the surface is soft enough to absorb the spices.

WARNING

Health risk

When thawing animal foodstuffs, it is imperative to remove the liquid that arises during thawing. It must never come into contact with other foodstuffs. Germs could be transmitted. Slide the unperforated cooking insert underneath the food. Pour away the collected thawing liquid from meat and poultry. Then clean the sink and rinse with plenty of water. Clean the cooking insert in hot soapy solution or in a dishwasher. After defrosting, operate the steam oven for 15 minutes with Convection at 350 °F (approx. 180°C).

Foodstuff	Cooking receptacle	Temperature in °F (°C)	Heating function	Cooking time in min.	Remarks
Berries (300 g/10.5 oz.)	Perforated	115 - 120 (45 - 50)	* 	3 - 4	
Roast (1,000 g/2 lb)	Perforated	115 - 120 (45 - 50)	* 	45 - 60*	
Fish fillet (150 g/5 oz. each)	Perforated	115 - 120 (45 - 50)	* 	5 - 10*	
Vegetables (400 g/14 oz.)	Perforated	115 - 120 (45 - 50)	* 	5 - 7	
Goulash (600 g/21 oz.)	Perforated	115 - 120 (45 - 50)	* 	30 - 45*	
Chicken (1,000 g/2 lb)	Perforated	115 - 120 (45 - 50)	* 	45 - 60*	
Chicken leg (400 g/14 oz. each)	Perforated	115 - 120 (45 - 50)	* 	30 - 35*	

* You should add some extra time for this dish: switch off the appliance after the thawing time has elapsed and leaves dishes in the closed appliance for another 10 - 15 minutes so that they can thaw completely to their interior.

Boiling down

- In the steam oven, you can preserve fruit and vegetables without much effort.
- If possible, boil down foodstuffs directly after shopping or harvesting. Prolonged storage reduces vitamin content and leads easily to fermentation.
- Use only fruit and vegetables that are in a perfect state.
- The steam oven is not suitable for preserving meat.
- Check and conscientiously clean preserving jars, rubber rings, clamps and springs.
- Disinfect rinsed jars before preserving in your steam oven at 212 °F (100 °C) and 100% humidity for 20-25 minutes.
- Place preserving jars in the perforated cooking receptacles. They must not touch each other.
- Open the oven interior door after the cooking time has elapsed. Do not remove preserving jars from the oven interior until they have cooled down fully.

Foodstuff	Cooking receptacle	Temperature in °F (°C)	Humidity in %	Cooking time in min.	Remarks
Fruit and vegetables (in closed 0.75 l (approx. 0.5 pints) preserving jars)	Perforated	212 (100)	100	35 - 40	
Beans and peas (in closed 0.75 l (approx. 0.5 pints) preserving jars)	Perforated	212 (100)	100	120	

Extracting juice (soft fruits)

- You can effortlessly and cleanly extract berry juice in the steam oven.
- Place the berries in the perforated cooking insert and slide it into the third level from below. Slide in the unperforated cooking insert one level below it to collect the liquid.
- Leave the berries in the appliance until no more juice appears.
- You can then squeeze the berries dry in a dishtowel to preserve the last remainders of juice.

Foodstuff	Cooking receptacle	Temperature in °F (°C)	Humidity in %	Cooking time in min.	Remarks
Berries	Perforated + unperforated	212 (100)	100	60 - 120	

Preparing yoghurt

- You can prepare your own yoghurt in the steam oven.
- Heat up pasteurized milk to 195°F (90°C) on the cook-top to avoid disturbing the yoghurt cultures. Ultra heat treated milk (UH milk) does not need heating. (Note: If you produce yoghurt with cold milk, this will prolong the maturation time.)
- Important! Allow the milk to cool to 105°F (40°C) in a water bath to avoid destroying the yoghurt cultures.
- Stir natural yoghurt with declared yoghurt cultures into the milk (1 - 2 teaspoons of yoghurt for every 100 ml (approx. 2.1 pints)).
- In the case of yoghurt ferment, pay attention to the notes on the packaging.
- Pour the yoghurt into rinsed jars.
- You can disinfect the rinsed jars in your steam oven at 212°F (100°C) and 100% humidity for 20 - 25 minutes before pouring in the yoghurt. Make sure you allow the jars and the oven interior to cool down before you pour the yoghurt into the jars and place the jars in the appliance.
- After preparing it, place the yoghurt in the fridge.
- To prevent the yoghurt from going sour, add skimmed milk powder (1 - 2 tablespoons per liter (approx. 2 pints) to the milk before heating it.

Foodstuff	Cooking receptacle	Temperature in °F (°C)	Humidity in %	Cooking time in min.	Remarks
Yoghurt mixture (in sealed jars)	Unperforated	115 (45)	100	240 - 360	

Preparing bulky food

- You can remove the side slide-in racks to prepare bulky food.
- To do this, undo the knurled nuts on the front of the slide-in racks and pull out the racks toward you (see section entitled **Removing slide-in racks**).
- Place the rack directly on the bottom of the oven interior and then place the food or the roaster on the rack. Do not place the food or the roaster directly on the bottom of the oven interior.

Acrylamide in foodstuffs

Which foods are affected?

Acrylamide is mainly produced in grain and potato products that are heated to high temperatures, such as potato crisps, chips, toast, bread rolls, bread, fine baked goods (biscuits, gingerbread, cookies).

Tips for keeping acrylamide to a minimum when preparing food	
General	Keep cooking times to a minimum. Cook meals until they are golden brown, but not too dark. Large, thick pieces of food contain less acrylamide.
Baking	With convection max. 355° F (180°C).
Cookies	Egg or egg yolk reduces the production of acrylamide. Spread out a single layer evenly on the baking tray.
Oven fries	Cook at least 400 g at once on a baking tray so that the fries do not dry out.

Gaggenau

BSH Home Appliances Ltd.
1901 Main Street, Suite 600
Irvine, CA 92614
+1.877.442.4436
USA
www.gaggenau-usa.com

Gaggenau Hausgeräte GmbH

Carl-Wery-Straße 34
81739 München
GERMANY

GAGGENAU



9000880670 en-us (940207)