

# LIEBHERR

## Use and Care Manual

Combined fridge-freezer, fully  
integrated

## Mode d'emploi

Combiné réfrigérateur-  
congélateur, entièrement  
intégrable

## Instrucciones de uso

Combinado frigorífico-congelador,  
integrable en mueble alto

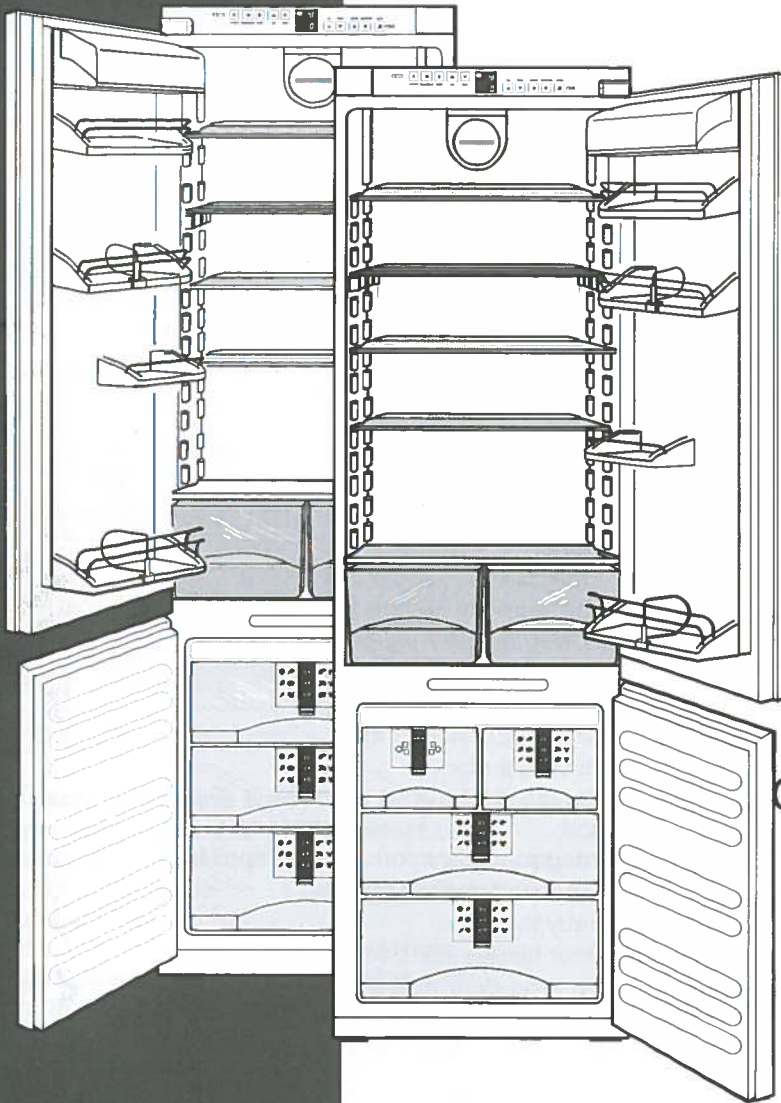

HC 1011/1060HC 1001/1050  
100712 7082698 - 00

# The appliance at a glance

## Contents

<b>1</b>	<b>The appliance at a glance</b> .....	<b>2</b>
1.1	Additional benefits.....	2
1.2	Overview.....	3
1.3	Range of appliance use.....	3
1.4	Conformity.....	3
1.5	Energy saving.....	3
<b>2</b>	<b>General safety information</b> .....	<b>4</b>
<b>3</b>	<b>Controls and displays</b> .....	<b>4</b>
3.1	Operating and control elements.....	4
3.2	Temperature display.....	4
<b>4</b>	<b>Start-up</b> .....	<b>5</b>
4.1	Transporting the appliance.....	5
4.2	Setting up the appliance.....	5
4.3	Disposal of packaging.....	6
4.4	Connecting the appliance.....	6
4.5	Switching on the appliance.....	6
<b>5</b>	<b>Operation</b> .....	<b>6</b>
5.1	Temperature display unit.....	6
5.2	Brightness of the temperature display.....	7
5.3	Child-proof lock.....	7
5.4	Door alarm.....	7
5.5	Temperature alarm.....	7
5.6	Fridge compartment.....	8
5.7	Freezer compartment.....	9
<b>6</b>	<b>Maintenance</b> .....	<b>11</b>
6.1	Defrosting with NoFrost.....	11
6.2	Cleaning the appliance.....	11
6.3	Cleaning the IceMaker.....	12
6.4	Replacing the interior light.....	12
6.5	Customer service.....	13
6.6	Appliance Information.....	13
<b>7</b>	<b>Troubleshooting</b> .....	<b>13</b>
<b>8</b>	<b>Putting appliance out of service</b> .....	<b>16</b>
8.1	Vacation Tips.....	16
8.2	Switching off the appliance.....	16
8.3	Decommissioning.....	16
<b>9</b>	<b>Disposing of the appliance</b> .....	<b>16</b>
<b>10</b>	<b>Liebherr Warranty Plan</b> .....	<b>16</b>

Congratulations on the purchase of your new appliance. With this purchase, you have chosen all the advantages of the latest refrigeration technology, guaranteeing you a high-quality appliance with a long life span and high operating safety.

The equipment of your appliance gives you the highest level of day-to-day ease of operation.

Together we are making an active contribution to the conservation of our environment by purchasing this appliance which is manufactured in an environmentally friendly process with the use of recyclable materials.

We hope you enjoy your new appliance.

The manufacturer is constantly working to improve all models. Therefore please understand that we reserve the

right to make design, equipment and technical modifications.

To get to know all the benefits of your new appliance, please read the information contained in these instructions carefully.

The instructions apply to several models, so there may be differences. Sections which only apply to certain appliances are indicated with an asterisk (\*).

**Instructions for action are marked with a ►, the results of action are marked with a ▷.**

## 1 The appliance at a glance

### 1.1 Additional benefits

- CFC free
- Energy-optimized refrigerant circuit
- Energy-efficient insulation
- Low energy consumption
- User-friendly electronic controls
- Active function indicators
- Temperature can be controlled in the appliance independent of ambient conditions according to its climate rating - Temperature can be displayed as °C or °F
- The appliance defrosts automatically - no need to spend time defrosting
- Large refrigeration capacity
- Safety glass storage shelves
- Adjustable door shelves for tall bottles
- Large freezing capacity
- Shelves can be removed to make space for large items.
- Freezer over-temperature alarm
- Quick-freeze feature for fresh food (SuperFrost)
- Power failure/"frost-control" display
- All freezer drawers suitable for quick-freeze
- Freezer compartment light
- Bright LED interior light\*
- Door ajar alarm
- Handle grips on all extra-large drawers for easy transport
- Integrated transport grips on appliance housing
- Transport castors at back
- Easy to clean
- Door hinges can be reversed
- Door-on-door system for easy kitchen cabinet installation
- Soft stop mechanisms on both doors\*

## 1.2 Overview

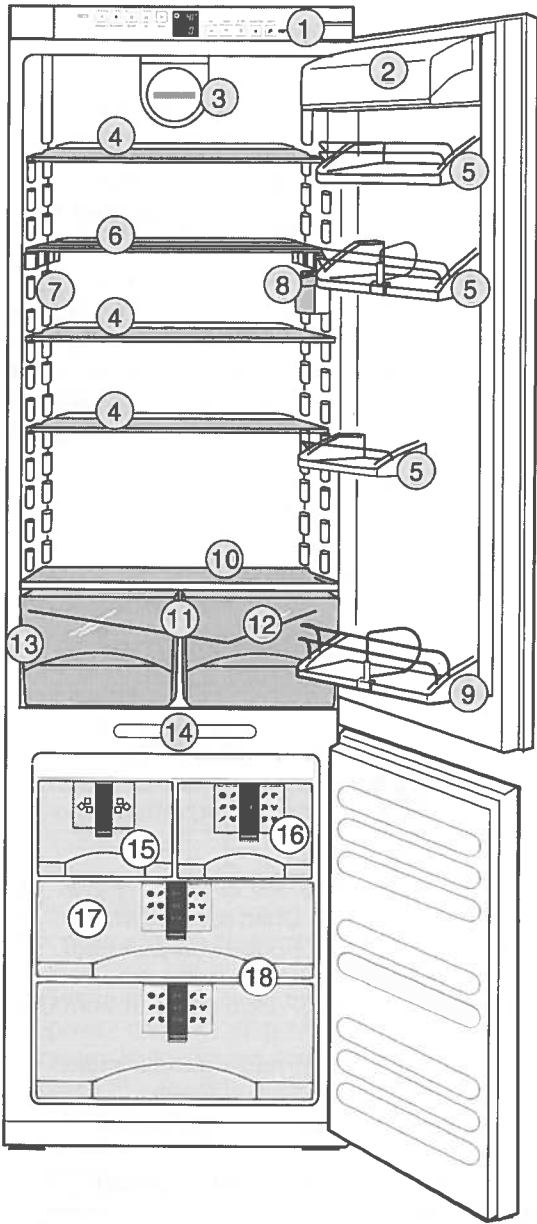

Fig. 1

- |  |   |
|--|---|
| (1) Operating and control elements                             | (10) Coldest zone                       |
| (2) Butter and cheese compartment                              | (11) Vegetable drawer                   |
| (3) Fan  | (12) Drain hole                         |
| (4) Shelf, moveable  | (13) Rating plate                       |
| (5) Storage rack for jars                                      | (14) LED lighting, freezer compartment* |
| (6) Shelf, can be split  | (15) IceMaker*                          |
| (7) LED lighting, refrigerator compartment*                    | (16) Info system                        |
| (8) Lighting with incandescent lamp, refrigerator compartment* | (17) Freezer compartment                |
| (9) Door rack for tall bottles                                 | (18) VarioSpace                         |

## 1.3 Range of appliance use

The appliance is only suitable for refrigerating food in a domestic environment or an environment that is similar to a domestic one. This includes, for example, use

- in staff kitchens, bed and breakfast establishments,
- by guests in country houses, hotels, motels and other accommodation facilities,
- for catering and similar services in wholesale premises

Only use the appliance in a normal domestic setting. No other types of use are permissible. The appliance is not suitable for storing and refrigerating medicines, blood plasma, laboratory preparations or similar substances and products referred to in CMDCAS and FDA 510 (k). Misuse of the appliance may lead to damage to or spoiling of the goods stored. In addition the appliance is not suitable for operating in areas at risk of explosions.

The appliance is set to operate within specific ambient temperature limits according to its climate rating. The climate rating for your appliance is printed on the rating plate.

### Note

- Compliance with the specified ambient temperatures is required, otherwise the refrigeration performance is reduced.

Climate rating	for ambient temperatures from
SN	50 °F (10 °C) to 90 °F (32 °C)
N	61 °F (16 °C) to 90 °F (32 °C)
ST	61 °F (16 °C) to 101 °F (38 °C)
T	61 °F (16 °C) to 110 °F (43 °C)

## 1.4 Conformity

The refrigerant circuit has been tested for leaks. When installed, the appliance complies with the relevant safety regulations and the safety standards UL250 and CAN/CSA C22.2 No. 63-93.

## 1.5 Energy saving

- Always ensure good ventilation. Do not obstruct ventilation openings or grilles.
- Do not install the appliance in direct sunlight or next to an oven, heater, or similar heat source.
- Energy consumption depends on installation conditions such as the ambient temperature (see 1.3).
- Avoid opening the appliance door for any longer than necessary.
- The lower the temperature is set the higher the energy consumption.
- Store food logically (see The appliance at a glance).
- All food stored in the appliance should be well wrapped and covered. This prevents frost buildup.
- Only take food out for as long as necessary so that it does not get too warm.

## General safety information

- Storing hot food: let it cool to room temperature first.
- Defrost frozen food in the fridge.

## 2 General safety information

Read and follow these instructions. They contain safety advice which is important for safe and problem-free installation and operation. Always read and follow the safety advice.

### Dangers for the user:

- This appliance is not designed for persons (or children) with physical, sensory or mental impairment or persons who do not have sufficient experience and knowledge, unless they have been instructed in the use of the appliance by a person who is responsible for their safety and supervised at first. Supervise children so that they do not play with the appliance.
- When disconnecting the appliance from the outlet, always take hold of the plug. Do not pull on the cable.
- Disconnect the power plug or switch off the fuse if a fault occurs.
- Do not damage the mains power line. Do not operate the appliance from a defective mains power line.
- Repairs, work on the appliance and replacement of the power cord should only be carried out by the customer service department.
- Only install and connect the appliance in accordance with the instructions.
- Only operate the appliance after it has been installed.
- Please keep the instructions and pass them on to any future owner.
- All repairs to or work on the IceMaker must only be carried out by the customer service department or other specialist engineers trained to do this.\*
- The manufacturer is not liable for damage arising from incorrect connection to the water supply.\*

### Risk of fire:

- Do not operate the appliance near explosive gases.
- Do not store explosive materials or spray cans with flammable propellants, such as e.g. butane, propane, pentane, etc. in the appliance. You can recognize such spray cans by the printed contents or a flame symbol. Any leaking gasses can be ignited by electrical components.
- High-proof alcohol should only be stored tightly sealed and standing upright. Any leaking alcohol could be ignited by electrical components.

### Tipover hazard:

- Do not stand or climb on the plinth, drawers, doors, etc. This applies in particular to children.

### Risk of food poisoning:

- Do not consume food that has passed its best before date.

### Danger of frostbite, feelings of numbness and pain:

- Avoid continued skin contact with the cold surfaces or chilled/frozen food or adopt protective measures, e. g. use gloves. Do not consume ice cream (especially

sherbets) and ice cubes immediately when they are too cold.

Follow the specific instructions in the other sections:

	DANGER	indicates a hazardous situation, which if not avoided, will result in death or serious injury.
	WARNING	indicates a hazardous situation, which if not avoided, could result in death or serious injury.
	CAUTION	indicates a hazardous situation, which if not avoided, will result in minor or moderate injury.
	NOTICE	indicates a hazardous situation, which if not avoided, could result in damage to property.
	Note	indicates useful advice and tips.

## 3 Controls and displays

### 3.1 Operating and control elements

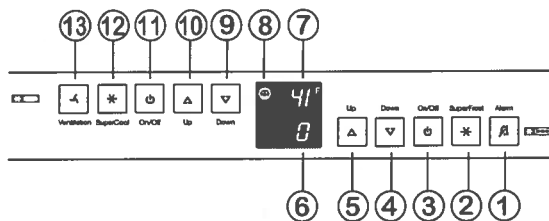

Fig. 2

- |   |                                       |
|---|---------------------------------------|
| (1) Alarm button                            | (8) Child safety symbol               |
| (2) SuperFrost button                       | (9) Fridge compartment Down           |
| (3) Freezer compartment On/Off button       | (10) Fridge compartment Up            |
| (4) Freezer compartment Down button         | (11) Fridge compartment On/Off button |
| (5) Freezer compartment Up button           | (12) SuperCool button                 |
| (6) Freezer compartment temperature display | (13) Ventilation button               |
| (7) Fridge compartment temperature display  |                                       |

### 3.2 Temperature display

The following is displayed in normal operation:

- the highest freezer temperature
- the average fridge temperature

The freezer compartment temperature display is flashing:

- the temperature setting has been changed
- after switch-on the temperature is not yet cold enough
- the temperature has risen several degrees

Dashes are shown on the display:

- the freezer temperature is above 32 °F (0 °C).

The following displays indicate malfunction. Possible causes and corrective actions: (see Troubleshooting).

- nR
- F0 through F5

## 4 Start-up

### 4.1 Transporting the appliance



#### CAUTION

Risk of injury or damage if incorrectly transported.

- ▶ Transport the appliance in its packaging.
- ▶ Transport the appliance upright.
- ▶ Do not move the appliance on your own.

### 4.2 Setting up the appliance



#### WARNING

Risk of fire due to moisture!

If live parts or the power cord get wet, this can cause a short circuit.

- ▶ The appliance is designed for use in enclosed spaces. Do not operate the appliance in open space or in damp areas or where there is spray.
- ▶ Only operate the appliance after it has been installed.



#### WARNING

Risk of fire due to short circuit.

If the power cable or plug of the appliance or another appliance and the back of the appliance touch each other the power cable or plug will be damaged by the vibrations of the appliance which could lead to a short circuit.

- ▶ Install the appliance so that it does not touch any plugs or power cables.
- ▶ Do not connect the appliance or other appliances to the sockets on the back of the appliance.



#### WARNING

Danger of fire and damage!

- ▶ Do not place devices that give off heat, e.g. microwaves, toasters, etc. on the appliance.



#### CAUTION

Risk of personal injury!

- ▶ Have two people move this appliance into place.

#### NOTICE

Risk of damage caused by condensation

Installing the appliance next to any other refrigerator or freezer can cause condensation or damage to the Liebherr appliance.

- ▶ Do not install this appliance next to any other refrigerator or freezer except another Liebherr model. Liebherr models are designed to allow side-by-side installation. They are equipped with a heating system to eliminate condensation when refrigerators or freezers are installed side-by-side.

#### NOTICE

Risk of damage for the finished floor surface!

- ▶ Protect the finished floor surface before you uncrate the unit.

Verify that:

- The floor under the appliance is flat and level.
- The floor can support the appliance's weight plus approximately 1200 pounds (544 kg) of food weight.
- The appliance is not placed in direct sunlight or near the stove, range top, radiators and similar heat sources.
- The kitchen cabinet that the appliance is installed in is shimmed to the floor level if the floor heights are not equal.
- Cutout dimensions are accurate.
- Electrical outlet is in correct location.
- The air flow is not restricted. Air flow must be provided for the appliance to operate properly. The factory air vents provide 31 square inches (200 cm<sup>2</sup>) of air flow per appliance. If you are replacing the air vents with an overlay, the air flow must be the same or greater than the factory air vents.
- ▶ Examine the unit and packaging for shipping damage. Contact the carrier immediately if you suspect there is any damage.
- ▶ Note the type (model, number), index, appliance/serial number, date of purchase and where purchased (see 6.6).
- ▶ Remove anything attached to the rear or side walls of appliance that would prevent proper installation or impede proper ventilation.
- ▶ Unscrew the red transport lock. Close the vacated retaining hole using the stopper (70).

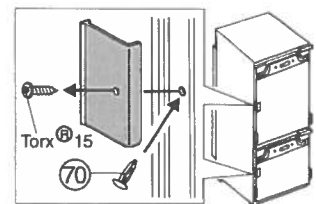

#### Note

- ▶ Clean the appliance (see 6.2).

If the appliance is set up in humid areas, condensation may build on the outside of the appliance.

- ▶ Always ensure proper ventilation.

# Operation

## 4.3 Disposal of packaging



### WARNING

Danger of suffocation from packaging materials and films!  
▶ Do not allow children to play with packaging materials.

The packaging is made from recyclable materials:



- Corrugated card/cardboard
  - Parts made of foamed polystyrene
  - Films and bags from polyethylene
  - Packing bands from polypropylene
  - Wood frame nailed together with a polyethylene window\*
- ▶ Take the packaging material to an official collection point.

## 4.4 Connecting the appliance



### WARNING

Electrical shock hazard!

- ▶ Start-up should only take place once the appliance has been installed according to these instructions.
- ▶ Electrically ground appliance.
- ▶ Do not ground to a gas pipe.
- ▶ Check with a qualified electrician if you are not sure the appliance is properly grounded.
- ▶ Do not have a fuse in the neutral or grounding circuit.
- ▶ Do not use an extension cord, power bar or a multiple socket adapter.
- ▶ Do not use a power cord that is frayed or damaged.



### WARNING

Electrical shock hazard!

This appliance is equipped with a three-prong (grounding) polarized plug for your protection against possible shock hazards. Electrical Grounding Required.

- ▶ Do not remove the round grounding prong from the plug.
- ▶ Do not use a two-prong grounding adapter.

- Wait 1 hour after installation before you plug in the appliance. This allows the refrigerant and system lubrication to reach equilibrium.
- Make sure incoming voltage is the same as the appliance rating. A 110-120 Volt, 60 Hz, 15 Amp electrical supply (20 Amp for side-by-side installations) circuit that is controlled by a circuit breaker or fuse is required.
- We recommend using a dedicated circuit for this appliance to prevent electrical overload.
- Follow all Federal, State and local electrical, fire and building codes and ordinances when installing the receptacle and / or the appliance.
- In some communities, a wall switch is required to turn power to the appliance ON and OFF.

- To reduce the risk of fire, electric shock, or personal injury, installation work and electrical wiring must be done by a qualified electrician in accordance with all applicable codes and standards, including fire-rated construction.
- The socket must be easily accessible so that the appliance can be disconnected from the mains quickly in an emergency. It must not be behind the back of the appliance.
- The top of the electric outlet must be located within 82-5/8 in. (2100 mm) from the top of the base in the cabinet.

## 4.5 Switching on the appliance

### Note

- ▶ To switch on the entire appliance, only the freezer compartment needs to be switched on.

Switch on the appliance 2 hours before loading with frozen food for the first time.

Do not load frozen foods until the temperature display reads 0 °F (-18 °C).



### 4.5.1 Switching on the freezer compartment

- ▶ Press On/Off button, freezer compartment *Fig. 2 (3)*.
- ▷ The refrigerator compartment temperature display indicates the set temperature.
- ▷ The temperature display for the freezer compartment will flash until the temperature is cold enough. If the temperature is greater than 32 °F (0 °C), flashing dashes will appear; if the temperature is lower than this, the set temperature will flash on the display.

### 4.5.2 Switching on the fridge compartment

- ▶ Press Fridge compartment On/Off button *Fig. 2 (11)*.
- ▷ The interior light comes on when the door is opened.
- ▷ The temperature display flashes. The fridge compartment is switched on.

## 5 Operation

### 5.1 Temperature display unit

The temperature display can be changed from °F to °C.

#### 5.1.1 To change the unit

- ▶ Activate setting mode: Press SuperFrost button *Fig. 2 (2)* for about 5 seconds.
- ▷ The SuperFrost button *Fig. 2 (2)* will flash.
- ▷ **c** is displayed in the temperature display.
- ▶ Using Freezer compartment Up button *Fig. 2 (5)*/ Freezer compartment Down button *Fig. 2 (4)* select °.
- ▶ To confirm: Briefly press SuperFrost button *Fig. 2 (2)*.



- ▶ Using Freezer compartment Up button *Fig. 2 (5)*/ Freezer compartment Down button *Fig. 2 (4)* select °F or °C.
- ▶ To confirm: Briefly press SuperFrost button *Fig. 2 (2)*.
- ▶ To exit setting mode: Press Freezer compartment On/Off button *Fig. 2 (3)*.

-or-

- ▶ Wait 5 minutes.
- ▷ The temperature is again displayed in the temperature display.

## 5.2 Brightness of the temperature display

You can adapt the brightness of the temperature display to the light conditions in the room in which it is installed.

### 5.2.1 Setting the brightness

The brightness can be set between h1 (minimum luminosity) and h5 (maximum luminosity).

- ▶ To activate setting mode: Press SuperFrost button *Fig. 2 (2)* for about 5 seconds.

▷ c is shown on the display.

▷ The SuperFrost button will flash.

- ▶ Press Freezer compartment Up button *Fig. 2 (5)* or Freezer compartment Down button *Fig. 2 (4)* to select h.

▶ To confirm: Briefly press SuperFrost button *Fig. 2 (2)*.

▶ To set the display brighter: Press Freezer compartment Up button *Fig. 2 (5)*.

▶ To set the display darker: Press Freezer compartment Down button *Fig. 2 (4)*.

▶ To confirm: Press SuperFrost button *Fig. 2 (2)*.

▷ The brightness is set to the new value.

▶ To deactivate setting mode: Press Freezer compartment On/Off button *Fig. 2 (3)*.

-or-

- ▶ Wait 5 minutes.

▷ The temperature is again displayed in the temperature display.

## 5.3 Child-proof lock

You can use the child-proof lock to lock the buttons. This means that children cannot accidentally switch off the appliance when playing.

### 5.3.1 Switching on the child-proof lock

- ▶ To activate setting mode: Press SuperFrost button *Fig. 2 (2)* for about 5 seconds.

▷ c is shown on the display.

▷ The SuperFrost button will flash.

▶ Press the SuperFrost button *Fig. 2 (2)* briefly to confirm.

▶ To switch on: Using Freezer compartment Up button *Fig. 2 (5)* or Freezer compartment Down button *Fig. 2 (4)* select c1.



- ▶ To switch off: Using Freezer compartment Up button *Fig. 2 (5)* or Freezer compartment Down button *Fig. 2 (4)* select c0.

▶ To confirm: Press SuperFrost button *Fig. 2 (2)*.

▷ If the Child-proof lock symbol *Fig. 2 (8)* lights up, the child-proof lock is switched on.

▶ To deactivate setting mode: Press Freezer compartment On/Off button *Fig. 2 (3)*.

-or-

- ▶ Wait for 5 minutes.

▷ The temperature is again displayed in the temperature display.

## 5.4 Door alarm

If the door is open for longer than 180 seconds, the acoustic warning sounds.

The acoustic warning stops automatically when the door is closed.

### 5.4.1 Switching off the door alarm

The acoustic warning can be switched off when the door is open. The acoustic warning remains switched off as long as the door is open. When the door is closed, the alarm function is active again.

▶ Press Alarm button *Fig. 2 (1)*.

▷ The door alarm stops.

## 5.5 Temperature alarm

If the freezer temperature is not cold enough, the audible warning sounds.

At the same time, the temperature display will flash.

The cause of a temperature being too high may be:

- Hot fresh food was placed in the appliance.
- When sorting and removing food from the appliance, too much warm ambient air got in.
- The power was cut off for a while.
- The appliance is faulty.

The audible warning automatically ceases, and the temperature display stops flashing when the temperature is cold enough again.

If the alarm status remains: (see Troubleshooting).

### Note

If the temperature is not cold enough, food may spoil.

▶ Check the quality of the food. Do not consume spoiled food.

### 5.5.1 Switching off the temperature alarm

The acoustic warning can be switched off. When the temperature is cold enough again, the alarm function is active again.

▶ Press Alarm button *Fig. 2 (1)*.

▷ The acoustic warning ceases.

# Operation

## 5.6 Fridge compartment

The natural circulation of air in the refrigerator compartment results in zones with differing temperatures. It is coldest directly above the vegetable drawers and at the rear wall. It is warmest at the top front of the compartment and in the door.

### 5.6.1 Arranging Food

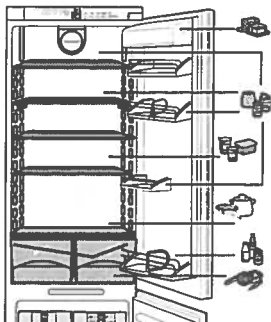

Fig. 3

### 5.6.2 Refrigerating food

#### Note

- ▶ Do not load the door with more than 35 lbs (16 kg) of food.

#### Note

Insufficient ventilation results in an increase in energy consumption and reduction of the refrigerating performance.

- ▶ Never block the air slits in the fan.
- ▶ Use recyclable plastic, metal, aluminum and glass containers and cling film to wrap foods.
- ▶ Always use closed containers for liquids and for food that may give off or be tainted by odor or flavor transfer or cover them.
- ▶ Foods which give off a large amount of ethylene gas and those that are sensitive to this gas, such as fruit, vegetables and salad, should always be separated or wrapped so as not to reduce the storage life; for example, do not store tomatoes together with kiwi fruits or cabbage.
- ▶ Use the front floor area of the fridge compartment only to set down food to be refrigerated temporarily, e.g., when rearranging or sorting the contents of the fridge. Do not leave the food there, as it may be pushed back or tipped over when the door is closed.
- ▶ Do not store food too close together to enable sufficient air circulation.
- ▶ To ensure bottles do not tip over: move the bottle holder.

### 5.6.3 Setting the temperature

The temperature can be set from 46 °F (7 °C) to (2 °C), (5 °C) is recommended.

- ▶ To set a higher temperature: press the Fridge compartment Up button *Fig. 2 (10)*.

- ▶ To set a lower temperature: press the Fridge compartment Down button *Fig. 2 (9)*.
- ▷ When the button is pressed for the first time, the previously set value is indicated on the fridge compartment temperature display.
- ▶ To change the temperature in 1 °F (1 °C) increments: briefly press the button.
- ▶ To change the temperature continuously: hold the button down.
- ▷ The value is displayed flashing during the setting operation.
- ▷ The actual temperature is displayed about 5 seconds after the last press of a button. The temperature slowly adjusts to the new value.

### 5.6.4 SuperCool

With SuperCool you switch to the highest cooling performance to reach lower cooling temperatures. Use SuperCool to rapidly cool large quantities of food.

When SuperCool is activated, the fan runs. The appliance operates with maximum refrigeration. The noise of the refrigeration unit may be temporarily louder as a result.

SuperCool will use more energy than normal operation.

#### Cooling with SuperCool

- ▶ Briefly press the SuperCool button *Fig. 2 (12)*.
- ▷ The SuperCool button *Fig. 2 (12)* lights up.
- ▷ The cooling temperature drops to the coldest value. SuperCool is switched on.
- ▷ SuperCool automatically switches itself off after about 6-12 hours. The appliance returns to work in the energy-saving normal mode.

#### To prematurely switch off SuperCool

- ▶ Briefly press the SuperCool button *Fig. 2 (12)*.
- ▷ The SuperCool button *Fig. 2 (12)* goes out.
- ▷ SuperCool is switched off.

### 5.6.5 Fan

The fan allows you to rapidly cool large amounts of fresh food or to achieve a relatively even distribution of temperature across all the storage levels.

Re-circulated air cooling is advisable:

- at high room temperatures (from approx. 95 °F (35 °C))
- in the case of high humidity

Re-circulated air cooling has a somewhat higher energy consumption. To save energy, the fan automatically switches off when the door is open.

#### Switching on the fan

- ▶ Briefly press Ventilation button *Fig. 2 (13)*.
- ▷ The Ventilation button lights up.
- ▷ The fan is switched on.

#### Switching the fan off (default)

- ▶ Briefly press Ventilation button *Fig. 2 (13)*.
- ▷ The Ventilation button lights up.
- ▷ The fan is switched off.



## 5.6.6 Repositioning the shelves



### CAUTION

Danger of lacerations!

The storage shelf can shatter if dropped or mishandled. You could cut yourself on the pieces of broken glass.

- ▶ Only remove storage shelves when there is nothing on them.

Extension stops secure the shelves against being accidentally pulled out.

- ▶ Lift the shelf and pull out forward.
- ▶ Insert the shelf with the raised edge to the back pointing upwards.
- ▶ This prevents food from contacting and freezing to the back wall.

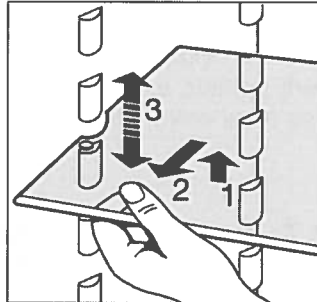

## 5.6.7 Using the split shelf



### CAUTION

Danger of lacerations!

The storage shelf can shatter if dropped or mishandled. You could cut yourself on the pieces of broken glass.

- ▶ Only remove storage shelves when there is nothing on them.

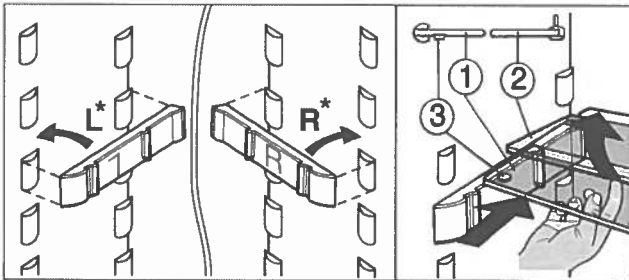

Fig. 4

- ▶ The glass shelf with stop face (2) has to be at the back.

## 5.6.8 Repositioning the door racks

### Note

- ▶ Do not load the door with more than 35 lbs (16 kg) of food.

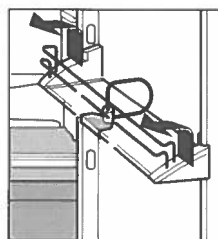

- ▶ Push rack up, pull forward, and reinsert in the reverse order.

Always take the butter and cheese compartment out together with the cover.

- ▶ To remove the cover: press one side of the butter and cheese compartment outwards until the hinge pin of the cover is released, then remove the cover sideways.

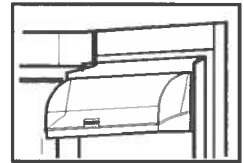

## 5.6.9 Removing the bottle holder

- ▶ Remove the bottle holder as per the illustration.
- ▶ Always take hold of the bottle holder by the plastic part.

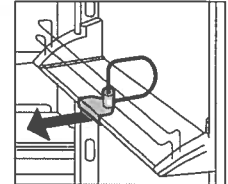

## 5.7 Freezer compartment

You can store frozen food, make ice cubes and freeze fresh food in the freezer compartment.

### 5.7.1 Freezing food

Each drawer can hold up to 55.12 lbs (25 kg) of frozen food; each plate can hold up to 77.16 lbs (35 kg).

After the door is closed, a vacuum is created. After closing the door, wait about 1 minute, then the door is easier to open.



### CAUTION

There is a risk of injury from pieces of broken glass.

Bottles and cans containing drinks can split or crack when frozen. This applies in particular to carbonated drinks.

- ▶ Do not freeze bottles and cans containing drinks.

So that the food is rapidly frozen through to the core, do not exceed the following quantities per pack:

- fruit, vegetables up to 2.2 lb (1 kg)
- meat up to 5.51 lbs (2.5 kg)

- ▶ Pack the food in portions in freezer bags, reusable plastic, metal or aluminum containers.

### 5.7.2 Defrosting food

- in the fridge compartment
- at room temperature
- in the microwave
- in the oven/fan oven



### WARNING

Danger of food poisoning!

- ▶ Do not re-freeze defrosted food.

- ▶ Only take out the amount of food that is required. Use defrosted food as quickly as possible.

# Operation

## 5.7.3 Setting the temperature in the freezer compartment

- The appliance is set as standard for normal operation. The temperature can be set between 8 °F (-14 °C) and -14 °F (-26 °C), 0 °F (-18 °C) is recommended.
- ▶ To set a higher temperature: press the Freezer compartment Up button *Fig. 2 (5)*.
  - ▶ To set a lower temperature: press the Freezer compartment Down button *Fig. 2 (4)*.
  - ▷ When the button is pressed for the first time, the previous value is indicated on the freezer compartment temperature display.
  - ▶ To change the temperature in 1 °F (1 °C) increments: briefly press the button.
  - or-
  - ▶ To change the temperature continuously: hold the button down.
  - ▷ The value is displayed flashing during the setting operation.
  - ▷ The actual temperature is displayed about 5 seconds after the last press of a button. The temperature slowly adjusts to the new setting.

## 5.7.4 SuperFrost

With this function you can rapidly freeze fresh food through to the core. The appliance works with maximum refrigerating performance. The sound of the refrigeration unit may be temporarily louder as a result.

Depending on how much fresh food is to be frozen you must switch SuperFrost on in advance - for a small amount of food to be frozen, about 6 hours, for the maximum amount about 24 hours before putting the food in.

Package the food and place it inside across as wide an area as possible. Do not bring food that is to be frozen into contact with products that are already frozen to prevent these items from starting to thaw.

You do not need to switch SuperFrost on in the following cases:

- when placing frozen food in the freezer
- when freezing up to about 2 kg of fresh food a day

### Freezing with SuperFrost

- ▶ Briefly press the SuperFrost button *Fig. 2 (2)* once.
- ▷ The SuperFrost button *Fig. 2 (2)* lights up.
- ▷ The freezer temperature drops, the appliance works with maximum refrigerating capacity. When a small amount of food is to be frozen.
  - ▶ Wait approx. 6 hrs.
  - ▶ Place packaged food in the upper drawers.
- ▶ When the maximum amount of food is to be frozen.
  - ▶ Wait approx. 24 hrs.
- ▷ SuperFrost is automatically switched off. At the earliest after 30 hours, at the latest after 65 hours, depending on the quantity placed inside the appliance.
- ▷ The SuperFrost button *Fig. 2 (2)* goes out when the freezing process is complete.

- ▷ The appliance returns to work in the energy-saving normal mode.

## 5.7.5 Drawers

### Note

Insufficient ventilation results in an increase in energy consumption and reduction of the refrigerating performance.

For appliances with NoFrost:

- ▶ Leave the bottom drawer in the appliance.
- ▶ Never block the air slits in the fan on the rear wall.

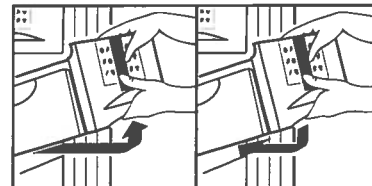

- ▶ To store frozen food directly on the shelves: pull the drawer forward and lift it out.

## 5.7.6 Shelves

- ▶ To remove shelf: lift it at the front and pull out forward.
- ▶ To reinsert shelf: simply slide it in as far as it will go.



## 5.7.7 VarioSpace

In addition to the drawers, you can also take out the shelves. This gives you space for large frozen items. Poultry, meat, large joints of game and tall bakery items can be frozen and then presented whole.

- ▶ Each drawer can hold up to 55.12 lbs (25 kg) of frozen food; each plate can hold up to 77.16 lbs (35 kg).

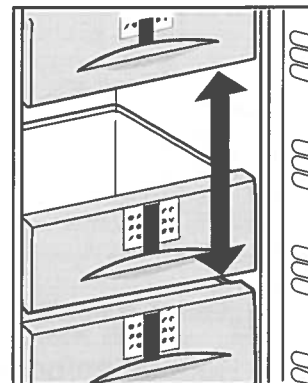

## 5.7.8 Info system

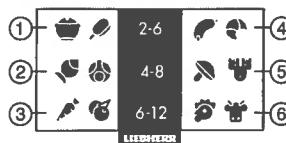

Fig. 5

- (1) Ready meals, ice cream
- (2) Pork, fish
- (3) Fruit, vegetables
- (4) Sausages, bread
- (5) Game, mushrooms
- (6) Poultry, beef/veal

The numbers indicate the storage time in months for different types of frozen foods. The storage times given are guidelines.

## 5.7.9 IceMaker\*

The IceMaker is in the top drawer. The drawer is labeled "IceMaker".

Make sure that the following conditions are fulfilled:

- The appliance is level.
- The appliance is connected to the electricity supply.
- The freezer compartment is switched on.
- The minimum freezer temperature is 14 °F (-10 °C).
- The IceMaker is connected to the water supply.
- All air was bled from the waterline before starting the icemaker. The icemaker will only work if there is no air in the waterline.

### Switching on the IceMaker\*

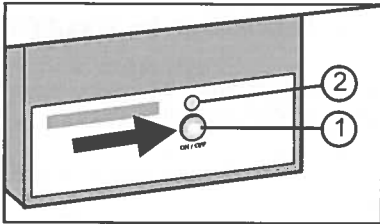

Fig. 6

- ▶ Pull out the drawer.
- ▶ Press On/Off button Fig. 6 (1) so that the LED Fig. 6 (2) lights up.
- ▶ Push in the drawer.

### Note

- ▶ The IceMaker only produces ice cubes when the drawer is completely closed.

### Producing ice cubes\*

The production capacity depends on the freezer temperature. The lower the temperature, the more ice cubes can be produced in a certain period.

The production capacity is 90- 100 ice cubes in 24 hours at a freezing temperature of 0 °F (-18 °C).

To have the maximum capacity of approx. 130 ice cubes in 24 hours, activate the SuperFrost Function. Be aware that this increases the energy consumption because the compressor will run constantly.

The ice cubes fall out of the IceMaker into the drawer. When the ice cubes reach a certain height in the drawer, no more ice cubes can be produced. The IceMaker will not fill the drawer to the top.

If large quantities of ice cubes are required, the complete IceMaker drawer can be swapped with the neighboring drawer. When you close the drawer, the IceMaker automatically restarts production.

When the IceMaker is switched on for the first time, it may take up to 24 hours for the first ice cubes to be produced.

### Note

Particles may accumulate in the IceMaker or water line the first time the appliance is used or after an extended period out of service.

- ▶ To achieve this, do not consume or use the ice cubes that are produced within 24 hours.

### Switching off the IceMaker\*

If ice cubes are not required, the IceMaker can be switched off independently of the freezer compartment.

When the IceMaker is switched off, the drawer of the IceMaker can also be used for freezing and storing food.

- ▶ Press the On/Off button for about 1 second until the LED goes out.
- ▶ Clean the IceMaker.
- ▶ This ensures that no water or ice remains in the IceMaker.

## 6 Maintenance

### 6.1 Defrosting with NoFrost

The NoFrost system defrosts the appliance automatically.

#### Fridge compartment:

The defrosted water is evaporated by the heat of the compressor. Drops of water on the back wall are a functional feature and completely normal.

- ▶ Clean the drain opening regularly so that the defrosted water can flow away (see 6.2) .

#### Freezer compartment:

The moisture condenses on the evaporator and is periodically defrosted and evaporated.

- ▶ The appliance does not need to be defrosted manually.

### 6.2 Cleaning the appliance



#### WARNING

Danger of electric shock.

- ▶ First, remove the plug or switch off the fuse.



#### CAUTION

Risk of injury or damage due to hot steam.

Hot steam can damage the surfaces and cause burns.

- ▶ Do not use steam cleaners.

# Maintenance

## NOTICE

Incorrect cleaning damages the appliance.

- ▶ Do not use concentrated cleaning agents.
- ▶ Do not use steel wool or sponges that scour or scratch.
- ▶ Do not use caustic or abrasive cleaning materials or those containing sand, chloride, chemicals or acids.
- ▶ Do not use chemical solvents.
- ▶ Do not damage or remove the rating plate on the inside of the appliance. It is vital for the customer service department.
- ▶ Do not pull off, kink or damage any cables or other components.
- ▶ Do not let cleaning water get into the drain gutter, the ventilation grille and electrical parts.
- ▶ Use soft cleaning cloths and a multi-purpose cleaning agent with a neutral pH value.
- ▶ Only use food-compatible cleaning and care agents inside the appliance.

- ▶ **Empty the appliance.**
- ▶ **Disconnect the power plug.**



- ▶ Clean the **plastic surfaces, outside and inside**, by hand using lukewarm water and a little dish washing liquid.
- ▶ To clean the **drain opening**: Remove deposits with a thin instrument, e.g. a cotton bud.

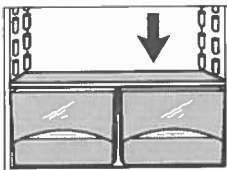

- ▶ Clean the **roller plates** in the dishwasher.
- ▶ Clean the **other fittings** by hand using lukewarm water and a little dish washing liquid.
- ▶ To clean, remove the **support bars** for the half glass plates.
- ▶ To dismantle **shelves**: remove trims and side parts
- ▶ To dismantle **door racks**: remove protective films from the trims

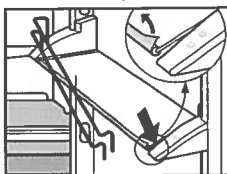

## After cleaning:

- ▶ Wipe the appliance and accessories dry.
- ▶ Connect the appliance and switch it on again.
- ▶ Switch on SuperFrost (see 5.7.4) .  
When the temperature is sufficiently cold:
- ▶ put the food back in the appliance.

## 6.3 Cleaning the IceMaker\*

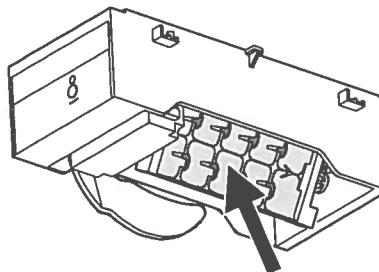

Fig. 7

The IceMaker must be switched on.

- ▶ Pull out the drawer and take out the ice.
- ▶ Clean the drawer with warm water and mild dish detergent.
- ▶ With the drawer pulled out, press and hold the On/Off button (for about 10 seconds).
- ▷ After about 1 second the LED goes out, the IceMaker is switched off.
- ▷ After about 10 seconds the LED flashes for about 60 seconds.
- ▶ Push the drawer in while the LED is flashing.
- ▷ The ice tray of the IceMaker rotates and tilts.
- ▶ Take out the drawer.
- ▶ Clean the ice tray with warm water. If necessary, use a mild dish detergent. Then rinse.
- To switch the IceMaker on again:
- ▶ Press the ON/OFF button until the LED lights up, then push the drawer in.
- ▷ The IceMaker starts to produce ice cubes.
- If dish detergent was used:
- ▶ Throw out the first three batches of ice cubes to get rid of any soapy residues.

## 6.4 Replacing the interior light\*

Light bulb data

- max. 25 W (25 W)
- 120 V
- Bulb fitting: E14
- Current and voltage must agree with the details on the rating plate.



### WARNING

Danger of electric shock.

- ▶ First, remove the plug or switch off the fuse.



### CAUTION

Cutting hazard!

- ▶ To prevent possible injury due to broken glass, use hand protection when replacing the interior light.

- ▶ Take hold of the light cover at the top and bottom *Fig. 8 (1)*.
- ▶ Unclip light cover *Fig. 8 (2)* at the back and unhook.
- ▶ Replace the light bulb *Fig. 8 (3)*.

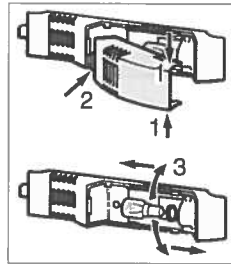

Fig. 8

When turning it, use a little more force to overcome the static friction of the seal. Make sure the seal sits cleanly in the light socket.

- ▶ Hook the cover in again at the back and clip in at the sides.

## 6.5 Customer service

First check whether you can remedy the fault yourself (see Troubleshooting). If this is not the case, please contact the Customer Service department. You can find the address in the enclosed customer service list.



### WARNING

Risk of injury from repairs by non-professionals.

- ▶ Repairs and work on the appliance and the power supply cable not expressly indicated (see Maintenance) should only be carried out by the customer service department.

- ▶ Read the appliance designation *Fig. 9 (1)*, service no. *Fig. 9 (2)* and serial no. *Fig. 9 (3)* from the rating plate. The rating plate is located inside the appliance on the left-hand side.

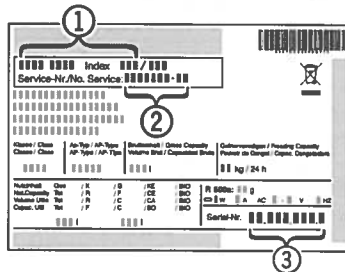

Fig. 9

- ▶ Notify the Customer Service department, specifying the fault, appliance designation *Fig. 9 (1)*, service no. *Fig. 9 (2)* and serial *Fig. 9 (3)* no.
- ▷ This will help us to provide you with a faster and more accurate service.
- ▶ Keep the appliance closed until the Customer Service engineer arrives.
- ▷ The food will stay cool longer.
- ▶ Disconnect the power plug (do not pull on the power cord to do this) or switch off the fuse.

## 6.6 Appliance Information

Make a note of this information when the appliance is installed:

Type Designation: \_\_\_\_\_

Service Number: \_\_\_\_\_

Appliance / Serial Number: \_\_\_\_\_

Date of purchase: \_\_\_\_\_

Where purchased: \_\_\_\_\_

## 7 Troubleshooting

Your appliance is designed and manufactured for reliable operation and a long lifespan. If a malfunction nonetheless occurs during operation, please determine if the malfunction is due to an operating error. If a service call determines operator error, you will be charged for the costs incurred, even during the warranty period. You may be able to rectify the following problems yourself:

Problem	Possible Cause	Correction
<b>The appliance does not work.</b>	The appliance is not switched on.	▶ Switch on the appliance.
	The power plug is not properly inserted in the wall socket.	▶ Check the power plug.
	The fuse in the wall socket is not OK.	▶ Check the fuse.
	Power failure	<ul style="list-style-type: none"> <li>▶ Keep the appliance closed.</li> <li>▶ Protect the food: place dry ice on top of the food or use an alternate freezer, if the power failure persists for some time.</li> <li>▶ Do not re-freeze defrosted food.</li> </ul>
<b>The compressor runs for a long time.</b>	When less refrigeration is required, the speed-controlled compressor switches to a low speed. Although the running time is increased as a result, energy is saved.	▶ This is normal in energy-saving models.

# Troubleshooting

Problem	Possible Cause	Correction
	SuperFrost function is activated.	▶ The compressor runs long to rapidly freeze food. This is normal.
	SuperCool function is activated.	▶ The compressor runs long to rapidly cool food. This is normal.
<b>A LED at the lower rear of the appliance (for the compressor) flashes regularly every 15 seconds*.</b>	The inverter is equipped with a diagnostic LED.	▶ The flashing is normal.
<b>Noises are too loud.</b>	The different speed levels of speed-controlled* compressors can cause them to generate various noises during operation.	▶ These noises are normal.
<b>A gurgling sound</b>	This sound comes from the refrigerant flowing in the refrigeration circuit.	▶ The sound is normal.
<b>A faint clicking sound</b>	The sound always occurs when the refrigeration unit (the motor) automatically switches on or off.	▶ The sound is normal.
<b>A hum. It is briefly a little louder when the refrigeration unit (the motor) switches on.</b>	The refrigeration increases automatically when the SuperFrost function is activated, fresh food has just been placed in the appliance or the door has been left open for a while.	▶ The sound is normal.
	The refrigeration increases automatically when the SuperCool function is activated, fresh food has just been placed in the appliance or the door has been left open for a while.	▶ The sound is normal.
	The ambient temperature is too high.	▶ Solution: (see 1.3)
<b>A low hum</b>	The sound occurs as a result of fan air flow.	▶ The sound is normal.
<b>Flow noise on the soft stop mechanism.*</b>	The sound is caused by the soft stop mechanism.	▶ The sound is normal.
<b>The temperature display indicates: F0 to F5.</b>	There is a fault.	▶ Contact the customer care department (see Maintenance).
<b>The temperature display indicates: nR.</b>	The freezer temperature rose too high during the last hours or days due to power failure or power interruption. When the power interruption is over, the appliance will continue to operate at the last temperature setting.	<ul style="list-style-type: none"> <li>▶ Press the Alarm button <i>Fig. 2 (1)</i>.</li> <li>▷ The warmest temperature reached during the power failure is displayed in the temperature display for about 60 seconds. Then the electronics again indicate the current freezer temperature</li> <li>▶ To delete the display of the warmest temperature ahead of time: Press the Alarm button <i>Fig. 2 (1)</i>.</li> </ul>

Problem	Possible Cause	Correction
		▶ Check the quality of the food. Do not consume spoiled food. Do not re-freeze defrosted food.
<b>The IceMaker cannot be switched on.*</b>	The appliance and therefore the IceMaker are not connected.	▶ Connect the appliance (see Start-up).
<b>The IceMaker is not making ice cubes.*</b>	The IceMaker is not switched on.	▶ Switch the IceMaker on.
	The drawer of the IceMaker is not properly closed.	▶ Close the drawer properly.
	The water connection is not open.	▶ Open the water connection.
	The waterline was not bled of all air during installation	▶ Please contact your qualified installation plumber to ensure the above criteria is met before calling for service.
<b>The temperature is not cold enough.</b>	The door of the appliance is not closed properly.	▶ Close the appliance door.
	Insufficient ventilation.	▶ Clear ventilation grilles.
	The ambient temperature is too high.	▶ Solution: (see 1.3)
	The appliance was opened too frequently or for too long.	▶ Wait to see whether the required temperature resets itself by itself. If not, contact the customer service department. (see Maintenance).
	Too much fresh food was placed inside without SuperFrost.	▶ Solution: (see 5.7.4)
	The temperature is incorrectly set.	▶ Set to a colder temperature and check after 24 hours
	The appliance is too near to a heat source.	▶ Solution: (see Start-up).
<b>Display show two dashes ("-").</b>	The freezer temperature display will only show temperatures that are below freezing.	▶ When initially starting the appliance it will not be below freezing. It will take three to five hours (depending on ambient conditions) for freezing temperatures to be achieved and thus displayed numerically.
	The freezer temperature has risen above zero degrees due to a power failure or power interruption.	▶ See also "Power failure" and "nA"
<b>The interior light is not on.</b>	The appliance is not switched on.	▶ Switch on the appliance.
	The door was open for longer than 15 minutes.	▶ The interior light automatically switches itself off if the door has been open for about 15 minutes.
	If the interior light is not on but the temperature display is lit, the bulb is faulty.*	▶ Replace the light bulb. (see Maintenance).*
	The LED light is faulty or the cover is damaged:*	 <b>WARNING*</b> Risk of injury from electrical shock. Live parts are under the cover. ▶ The LED interior light should only be replaced or repaired by the Customer Service department or by engineers trained to do so.

# Putting appliance out of service

Problem	Possible Cause	Correction
		 <b>WARNING*</b> Risk of injury from class 1M laser radiation. ► Do not look inside when the cover is open.

## 8 Putting appliance out of service

### 8.1 Vacation Tips

**Short vacations:** If you will be away for less than four weeks

- Use all perishables.
- Freeze other items.
- Turn off the refrigerator compartment.
- Turn off the icemaker.\*
- Shut down the water supply to the icemaker.\*

**Long vacations:** If you will be away for a month or more

- Remove all food from the appliance.
- Turn OFF the appliance.
- Clean the appliance (see 6.2) .
- Leave the door open to prevent unpleasant odors.
- ▷ This will also keep mold from building up.
- Turn off the icemaker.\*
- Shut off the water supply to the icemaker.\*

### 8.2 Switching off the appliance

**Note**

- To switch off the entire appliance, only the freezer compartment needs to be switched off.

#### 8.2.1 Switching off the freezer compartment

- Press and hold down the freezer compartment On/Off button *Fig. 2 (3)* for approx. 2 seconds.
- ▷ The temperature displays are dark. The appliance is switched off.



#### 8.2.2 Switching off the fridge compartment

**Note**

- The fridge compartment can be switched off independently of the freezer.
- Press and hold down the chiller compartment On/Off button *Fig. 2 (11)* for approx. 2 seconds.
- ▷ The fridge compartment temperature display *Fig. 2 (7)* is dark. The fridge compartment is switched off.

### 8.3 Decommissioning

- Empty the appliance.

- Put the IceMaker in the cleaning position (see Maintenance).\*
- Disconnect the power plug.
- Clean the appliance (see 6.2) .



- Leave the door open to prevent bad smells.

## 9 Disposing of the appliance

Follow the local regulations for the disposal of appliances. Old appliances can be dangerous. Contact the local refuse collection department for additional information.



**DANGER**

- There is a risk of suffocation. Children playing can shut themselves in and suffocate.
- Take the door(s) off.
  - Remove the drawers.
  - Leave the storage shelves in the appliance so that children cannot easily climb into the appliance.



**WARNING**

- Danger of electric shock.
- Cut off the plug from the power cord and discard.
  - Cut off the power cord from the discarded appliance. Dispose of separately from the appliance.

## 10 Liebherr Warranty Plan

**FULL TWO YEAR WARRANTY** - For two years from the date of original purchase, your Liebherr warranty covers all parts and labor to repair or replace any part of the product which proves to be defective in materials or workmanship.

**FULL FIVE YEAR WARRANTY** - For five years from the date of original purchase, your Liebherr warranty covers all parts and labor to repair or replace any components that prove to be defective in materials or workmanship in the sealed system. The "Sealed System" means only the compressor, condenser, evaporator, drier and all connecting tubing.

**LIMITED 6TH THROUGH 12TH YEAR WARRANTY** - From the 6<sup>th</sup> through 12<sup>th</sup> year from the date of original purchase, your Liebherr warranty covers all parts that prove to be defective in materials or workmanship in the Sealed System (parts only).



## **TERMS APPLICABLE TO EACH WARRANTY**

All service provided by Liebherr under the warranty must be performed by authorized Liebherr service representatives, unless otherwise specified by Liebherr. Service will be provided in the home during normal business hours. This warranty applies only to products installed for normal residential use. Details regarding a non-residential warranty are available on request.

The warranty applies only to products installed in any one of the fifty states of the United States or the District of Columbia. The warranty does not cover any parts or labor to correct any defect caused by negligence, accident or improper use, maintenance, installation, service or repair, including but not limited to improper removal and reinstallation of the condensing unit.

**The remedies described above for each warranty are the only ones which Liebherr will provide, either under these warranties or under any warranty arising by operation of law. Liebherr will not be responsible for any consequential or incidental damages arising from the breach of these warranties or any other warranties, whether express, implied or statutory.**

Some states do not allow the exclusion or limitation of incidental or consequential damages so the above limitation or exclusion may not apply to you. This warranty gives you specific legal rights and you may also have other legal rights which vary from state to state.

To receive parts and/or service and the name of the Liebherr authorized service representative nearest you, contact your Liebherr dealer or distributor or contact the Liebherr designated national service provider:

in the US: [Liebherr@adcoservice.com](mailto:Liebherr@adcoservice.com) or call 1- 866 - LIEBHERR ( 1- 866 - 543-2437).

in Canada: [www.euro-parts.ca](http://www.euro-parts.ca) or call 1-888-LIEBHERR (1-888-543-2437).

**For Service and Parts in the U.S.:**

**Liebherr Service Center**

15545 N. 77th Street  
Scottsdale, AZ 85260  
Phone: (480) 998-0141  
Fax: (480) 998-7877

**Toll Free: 1-866-LIEBHERR or 1-866-543-2437**

[www.liebherr-appliances.com](http://www.liebherr-appliances.com)

**For Service and Parts in Canada:**

**EURO-PARTS**

579 Campbell Street,  
P.O. Box 759,  
Lucknow, Ontario, N0G 2H0  
Phone: (519)528-5005  
Fax: (519)528-5001

**Toll Free: 1-888-Liebherr or 1-888-543-2437**

[www.euro-parts.ca](http://www.euro-parts.ca)

**[www.liebherr-appliances.com](http://www.liebherr-appliances.com)**